

# INSTRUCTION MANUAL



## **MetRanger II**

---

**March 2010**

*Copyright © 2010  
Campbell Scientific (Canada) Corp.*

## WARRANTY AND ASSISTANCE

This equipment is warranted by CAMPBELL SCIENTIFIC (CANADA) CORP. ("CSC") to be free from defects in materials and workmanship under normal use and service for **twelve (12) months** from date of shipment unless specified otherwise. \*\*\*\*\* **Batteries are not warranted.** \*\*\*\*\* CSC's obligation under this warranty is limited to repairing or replacing (at CSC's option) defective products. The customer shall assume all costs of removing, reinstalling, and shipping defective products to CSC. CSC will return such products by surface carrier prepaid. This warranty shall not apply to any CSC products which have been subjected to modification, misuse, neglect, accidents of nature, or shipping damage. This warranty is in lieu of all other warranties, expressed or implied, including warranties of merchantability or fitness for a particular purpose. CSC is not liable for special, indirect, incidental, or consequential damages.

Products may not be returned without prior authorization. To obtain a Return Merchandise Authorization (RMA), contact CAMPBELL SCIENTIFIC (CANADA) CORP., at (780) 454-2505. An RMA number will be issued in order to facilitate Repair Personnel in identifying an instrument upon arrival. Please write this number clearly on the outside of the shipping container. Include description of symptoms and all pertinent details.

CAMPBELL SCIENTIFIC (CANADA) CORP. does not accept collect calls.

Non-warranty products returned for repair should be accompanied by a purchase order to cover repair costs.



**CAMPBELL SCIENTIFIC**  
C A N A D A C O R P .

11564 - 149 street - edmonton - alberta - T5M 1W7  
tel 780.454.2505 fax 780.454.2655

[www.campbellsci.ca](http://www.campbellsci.ca)

# ***MetRanger II Table of Contents***

---

<b>1. Introduction</b> .....	1
1.1 General Description .....	1
<b>2. Set Up Instructions</b> .....	2
<b>3. Connecting with a Palm Handheld and the     MetRanger II via PConnect Software</b> .....	7
<b>4. Using RAD (Short Haul) Modems</b> .....	9
<b>5. Additional Equipment</b> .....	10
<b>6. Maintenance</b> .....	11
<b>Appendix A</b> Sensor Specifications .....	A-1
<b>Appendix B</b> Setting Software Device Maps for Loggernet.....	B-1
<b>Appendix C</b> Packing List for the MetRanger II .....	C-1
<b>Appendix D</b> MetRanger II Program with Wiring & Data Output Lables ...	D-1
<b>Appendix E</b> Material Safety Data Sheets .....	E-1

# 1. Introduction

## 1.1 General Description

The MetRanger II is a quick deploy weather station transported within a single, mobile case. It is easily moved and installed by a single person without the use of any tools. In a fully configured system the MetRanger II can measure and record the following parameters:

- Wind Speed & Direction
- Air Temperature
- Relative Humidity
- Calculated Dewpoint and Windchill
- Barometric Pressure (2 options available)
- Rainfall (optional)



*MetRanger II*

The case has 8-inch wheels at one end and rubber gripped handles making it easy to manoeuvre by one individual over variable terrain.

Communication and data access options include:

- Direct Connection (Hand-held keypad (CR1000KD), Palm Pilot, or Laptop)
- Remote Connection via Short Haul Modems and interface cable

The MetRanger II comes pre-wired and pre-programmed. To make the station operational simply follow the Setup Instructions. See **Appendix C** for a list of all items included with your MetRanger II.

## 2. Setup Instructions

**Step 1** – Remove Tripod from case and loosen the tri-linear hand knob where the three legs meet the main mast. Turn the tripod upside down and gently pull two of the legs apart. This will slide the main tri-linear collar down the main mast allowing you to spread the tripod legs to the desired position. Ensure that you have a minimum clearance of ~16” between the top and bottom knobs. The enclosure needs to be mounted between these knobs on the main mast. Tighten knob to hold legs in the desired position. Take care that the tripod is on level ground as this will affect the electronic compass corrections to the wind direction readings. (**Do not over-tighten**)

**Step 2** – If using the guy wire assembly, remove from the mesh bag and slide it over the top of the main mast. It will rest on the permanent black retaining ring near the top of the mast. Insert the loop at the free end of the guy wire over the hook of the tie down peg. Insert pegs into ground after completing **Step 6**. (See Figure 1)

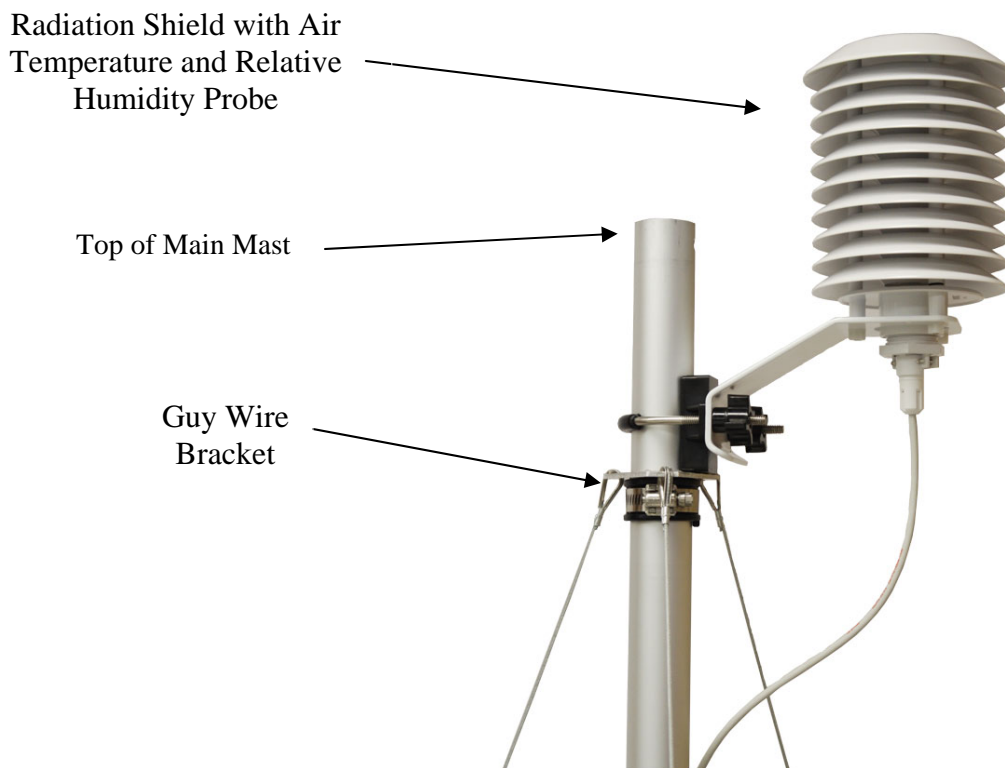

Figure 1. Radiation Shield & Guy Wire Assembly

**Step 3** – Remove the Air Temperature/Relative Humidity sensor housed in the white, circular radiation shield. Slide it over the tripod mast and let it rest on the guy wire collar or guy wire-retaining ring (if the guy wire is not being used). Do not tighten at this time. (See Figure 1)

**Step 4** – Remove the Wind Speed and Direction assembly. Slide its mounting post into the top of the main tripod mast until both buttons click into its lowest position. Both front and back spring-loaded buttons should protrude out of the lowest main mast mounting holes. There is a black mast coupler attached to this assembly which needs to be slid over the main mast, when it is in place tighten the knob of the coupler. **Note: Do not remove the wind sensor from the electronic compass, which is mounted below it on the same post. The alignment of these two sensors is critical in obtaining the correct wind direction.** (See Figure 2)

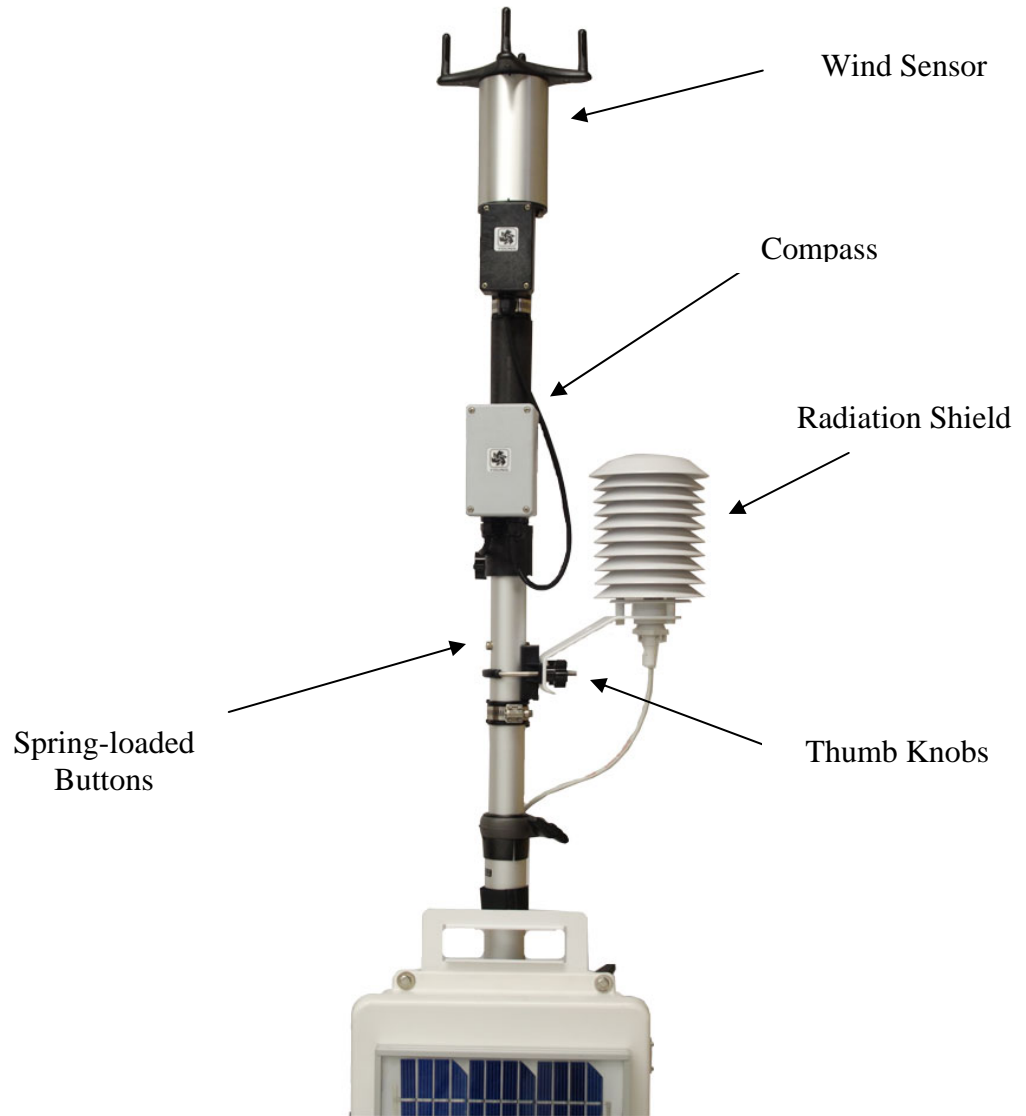

Figure 2. MetRanger II Components

The compass automatically corrects the wind direction to magnetic north. To convert the direction to true north, the magnetic deviation for the region where the MetRanger II is deployed must be accounted for. See **Section 6. Maintenance** for compass calibrating instructions.

**Step 5** – Move the radiation shield to the desired height and secure it in place using the thumb-knobs.

**Step 6** – Loosen upper knob on main tripod mast and slide the upper section of the mast until wind sensor is at the desired height (approximately 6 feet). Tighten knob. Insert the tie down peg into the ground at a point where the guy wire will remain taut. Repeat for all 3 guy wires.

**Step 7 (Optional)** – Remove the Rain Gauge from the case. Using the 3 pegs secure into the ground away from the tripod. Ensure the sensor is level. Plug cable connector into side of enclosure.

**Step 8** – Remove the white enclosure from the case. **Hold the enclosure using the built-in handle on the enclosure backplate.** Mount the enclosure directly above the tri-linear bracket (point at which all three legs attach to the tripod).

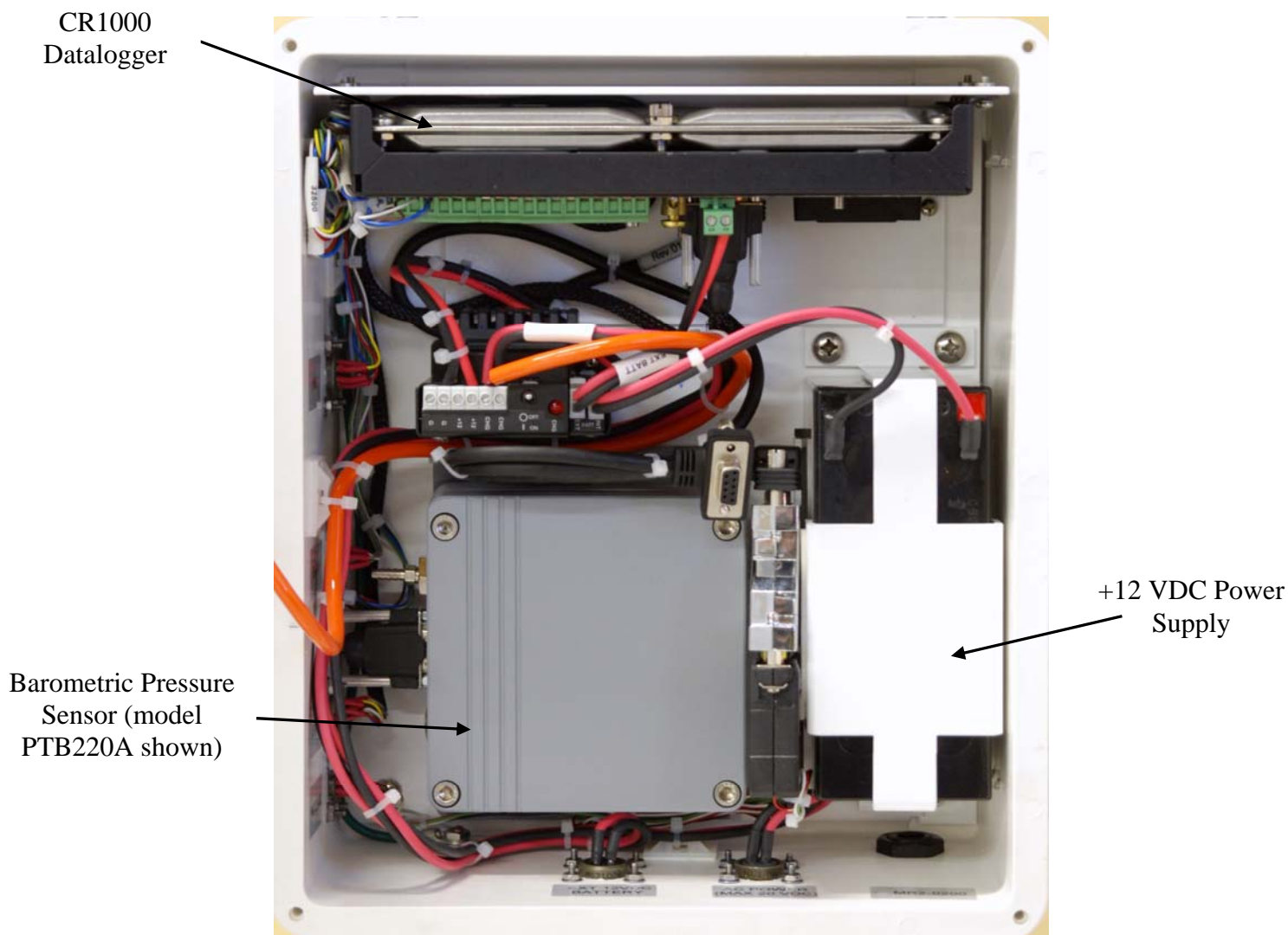

Figure 3. MetRanger II Enclosure

To attach the enclosure to the tripod mast, hold it securely by the handle against the mast and spin the top clamp handle clockwise until tight. Repeat the same procedure for the lower handle. **(Do not over tighten)** Ensure enclosure is south facing to maximize solar panel effectiveness.

**Step 9** – Connect the “Temp/RH”, “Wind” and “Rain” cables to the quick connectors on the side of the enclosure. Secure the cables to the mast with the Velcro straps.

**Step 10** – **Carefully** open the enclosure lid, being aware that sudden wind bursts may catch an open lid and cause damage. Locate the silver toggle switch, roughly in the middle of the enclosure. Place the toggle switch in the down position to turn the station on.

**Step 11** – Remove the CR1000KD (Keyboard and Display) from the protective case, and attach it to the “Serial I/O” port on the side of the enclosure using the Serial I/O cable. Once connected the display should say “CR1000 Datalogger” and list the date and time of the datalogger. It will also list the MetRanger II program and state that it is running.

**Step 12** – To view “real-time” readings use the following keystrokes on the handheld keypad (CR1000KD).

- Press Enter. This will take you to the main menu.
- Press Enter to select “Data”
- Press Enter to select “Real Time Tables”
- Press Enter to select the “Public” table

The measurements are as follows:

Location	Description
01:	Air Temperature (°C)
02:	Relative Humidity (%)
03:	Wind Speed (Knots)
04:	Wind Speed (km/h)
05:	Wind Speed (meters/second)
06:	Wind Speed (feet/second)
07:	Wind Direction (degrees)
08:	Dew Point (°C)
09:	Wind Chill (°C)
10:	Barometric Pressure #1 (mbar)
10:	Barometric Pressure #2 (mbar)
12:	Barometric Pressure #3 (mbar)
13:	Barometric Pressure Average (mbar)
14:	<i>Precipitation (mm) if present</i>
15:	Battery Voltage (volts)
16:	Watchdog Error Connection
17:	Low Battery Voltage Connection
18:	Lithium Battery Voltage (volts)
19:	Program Signature

**Note:** Use the up & down arrows on the keypad to scroll through the values. The CR1000KD will shutdown if left inactive for a minute. You will need to start step 12 from the beginning.

**Note:** The real-time readings are updated every 20 seconds. The exception is the Barometric Pressure sensor which is measured once every 15 minutes.

**Note:** Location 10 through 13 will only have values if the MetRanger II was supplied with a PTB220A Barometric Pressure Sensor. Location 14 will only have values if a rain gauge was supplied.

**Before disassembling Station** – Ensure the power switch is turned off or the battery may be drained and permanently damaged. To turn the station power off, place the silver toggle switch (same as in step 10) in the upward position

### 3. Connecting with a Palm Handheld and the MetRanger II via PConnect Software

The *PConnect* software and adaptor allows you to connect your Palm handheld (running Palm OS version 3.3 or later) to a Campbell Scientific datalogger to perform all of the standard datalogger support functions including:

- send and receive datalogger programs
- view and edit public variables
- collect data
- view data tables and graphically display data
- set flags and ports
- check and set the datalogger clock
- access the datalogger's remote keyboard mode through a terminal interface.

*PConnect* stores collected datalogger data in the Palm handheld's internal memory. When the Palm is HotSync'd with the desktop computer, this data is moved to a specified data folder on the PC. New data from each station is appended to any existing data file on the PC.

The HotSync process also synchronizes datalogger program files between the PC and Palm device. You can copy ".CR1" files to *PConnect's* datalogger programs folder on the PC and then use the HotSync process to transfer the ".CR1" files to the Palm device to subsequently send them to the datalogger. You can also retrieve programs from dataloggers to the Palm device and use the HotSync process to copy them to the PC. If there are two different programs – one on the Palm device and another in *PConnect's* programs folder on the PC – have the same name when you use HotSync, the ".CR1" on the PC will overwrite the ".CR1" on the Palm device.

## Connecting Your Palm Handheld to the Datalogger

The Palm handheld connects to the datalogger via the serial port at the bottom of the Palm handheld. A “HotSync Serial Cable” is required for your Palm handheld. Since this cable is unique to each Palm handheld model it is not included with the *PConnect* software but can be purchased separately at most office supply stores.

You must have *PConnect* software installed in your Palm handheld in order to communicate with the MetRanger II.

After connecting the “HotSync Cable” to the bottom of the Palm handheld, use the supplied “PConnector” adaptor to connect to the datalogger:

Note: Consult the *PConnect* manual for operation details.

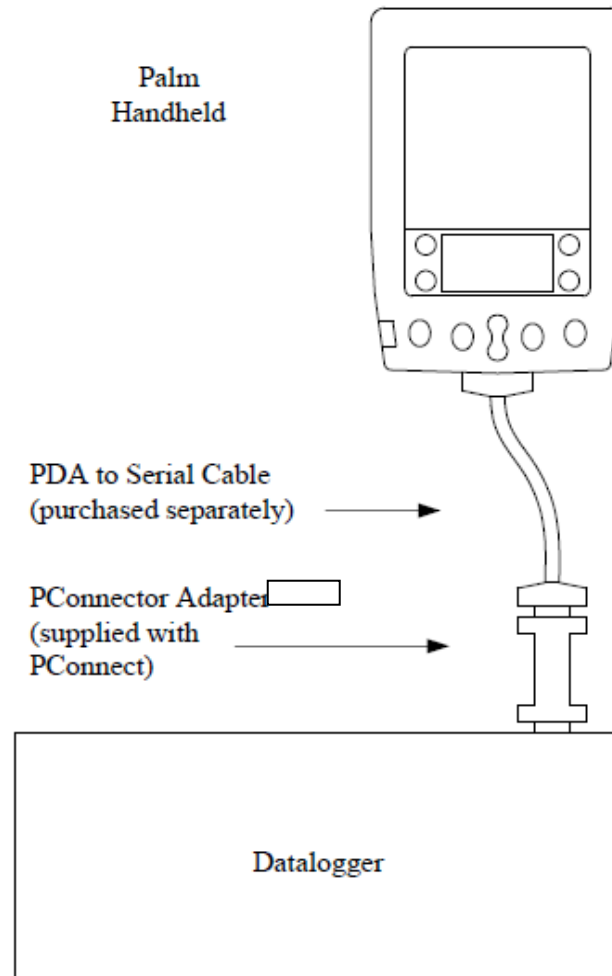

Figure 4. *PConnect* Connection Block Diagram

## 4. Using RAD (Short Haul) Modems

MetRanger II ships with a RAD modem system can communicate directly to a laptop or PC over long distances (up to 7km using 24 gauge wire) via a computer RS232 COM port. The system uses a four conductor cable (2 twisted pairs) with two RAD modems, one at each end. When purchased with a MetRanger II, the Rad modem system has the modem at the computer end pre-wired to the cable and a 25 to 9- pin adapter is included (for 9-pin RS232 ports). The other end has a circular connector that plugs into the side of the MetRanger II enclosure. Inside the enclosure another RAD modem is already connected to an SC932C Interface which connects the system to the datalogger.

Open the enclosure lid. Ensure that the SC12 ribbon cable from the SC932C is plugged into the CS I/O port on the CR1000 (second com port). Confirm that the RAD modem at this end is connected into the SC932C Interface.

You require one or more of the following Campbell Scientific software packages to be installed on your laptop or PC:

**PC200W** (downloadable from [www.campbellsci.ca](http://www.campbellsci.ca))

**PC208W** (may be purchased from Campbell Scientific)

**LoggerNet** (may be purchased from Campbell Scientific)

Once all connections are made you can communicate with the MetRanger II using one of these software packages. Refer to the software manual for instructions to set-up your station file. The computer treats the RAD modem system as a direct link. See **Appendix B** for example Setup screens.

Rad Modem Wiring (on computer end). Normally, this should already be wired on the end of the RAD COMM cable. The colour coded Connection for the SRM5A (DCE). This is for reference only.

Wire Colour	RAD Modem
Red	RCV +
Black	RCV -
Green	XMT +
White	XMT -

### RAD Modem Wiring at Computer End

## 5. Additional Equipment

The following is a list of supplemental cables and interfaces, which are included in the protective carrying case. Please note that only the items you have specified at the time of placing your MetRanger II order will be included in your specific case.

- 10 foot interface cable terminating in a 9-pin connector (labelled **Serial I/O** Cable). Used to communicate via the CR1000KD and SC929 interface cable (direct to laptop).
- One Palm Handheld to Datalogger interface connector. Used with a user supplied Palm handheld and interface cable.
- PConnect Software Disk. This software is loaded onto the users computer allowing communication to the MetRanger II via a user supplied Palm Pilot.
- Loggernet Software Disk. This software is loaded onto the user's computer if remote communications are required (i.e. Rad Modem).
- External 12VDC Battery (**BATT**) Cable is to be used when an external 12VDC battery is used to power the station. The cable has a red lead (+) and a black lead (-).

**Note:** Before connecting an external power supply, you will need to disconnect the leads of the internal battery from the regulator. Also follow Steps 10 and 12 for powering the station on or off.

- AC Power Adapter (**AC POW**) Cable to be used whenever the station is not in use to recharge the internal battery. This ensures it is always fully charged when required for deployment.
- **SC929** Interface cable to be used with 10 ft Serial I/O cable to allow communication between the MetRanger II and a laptop. The SC929 can be simply attached to the end of the 10 ft Serial I/O cable.
- Three Velcro straps, used to secure the sensor cables to the tripod mast.
- Guy wire assembly, with three pegs for securing the guy wires.
- Three pegs to secure the rain gauge to the ground upon deployment.

## 6. Maintenance

The most important issue with the MetRanger II is power. When the unit is not in use it should be plugged into AC power, using the included transformer to recharge the 8.5 AHr batteries. The connection point can be found on the underside of the enclosure.

**Recharging the MetRanger II when it is not in use will ensure that it is fully charged upon deployment!**

### **Wind Speed & Direction Sensor (model 85000)**

No field maintenance required. Return to factory for calibration every 24 to 48 months.

### **Air Temperature & Relative Humidity Probe (model HC-S3)**

Clean the radiation shield & filter cap as required  
24 months – calibrate

### **Raingauge (model TE525)**

12 months – calibrate

### **Compass Calibration**

The compass comes calibrated with parameters maintained in memory. However, it is possible for the unit to lose its calibration. To verify the wind direction reading, hold a handheld compass several feet from the sensor. Hold the sensor still while reading the wind direction (Public variable 'Wdir' ) using the handheld display connected to the Met Ranger II. If the MetRanger II wind direction is off by more than 30° (Note: the wind direction output is aligned to magnetic north and not true north) use the following procedure to calibrate the unit but make sure calibration is performed away from metal objects and as near to the field site as possible:

- Remove compass cover (Philips screws)
- Using the CR1000KD handheld keypad, set Flag 8 high from the Public Table (see Step 12 of Section 2). Once at the Flag 8 variable press enter and set the value to "true". This will activate the compass for 5 minutes and then put it back into sleep mode.
- Press and hold the calibrate button for 5 seconds (see Figure 5). The indicator light will begin to blink. See the 32500 The calibration button and light are located at SW1 at the top centre of the 32500 circuit board.

- Depress the spring loaded buttons (see Figure 3) and slowly rotate the compass section 360° twice while keeping the compass level during each revolution. Take about 1 minute for each revolution.
- After two revolutions, press and hold the calibration button until the indicator light stops blinking.
- Unit is now calibrated. Replace compass cover.

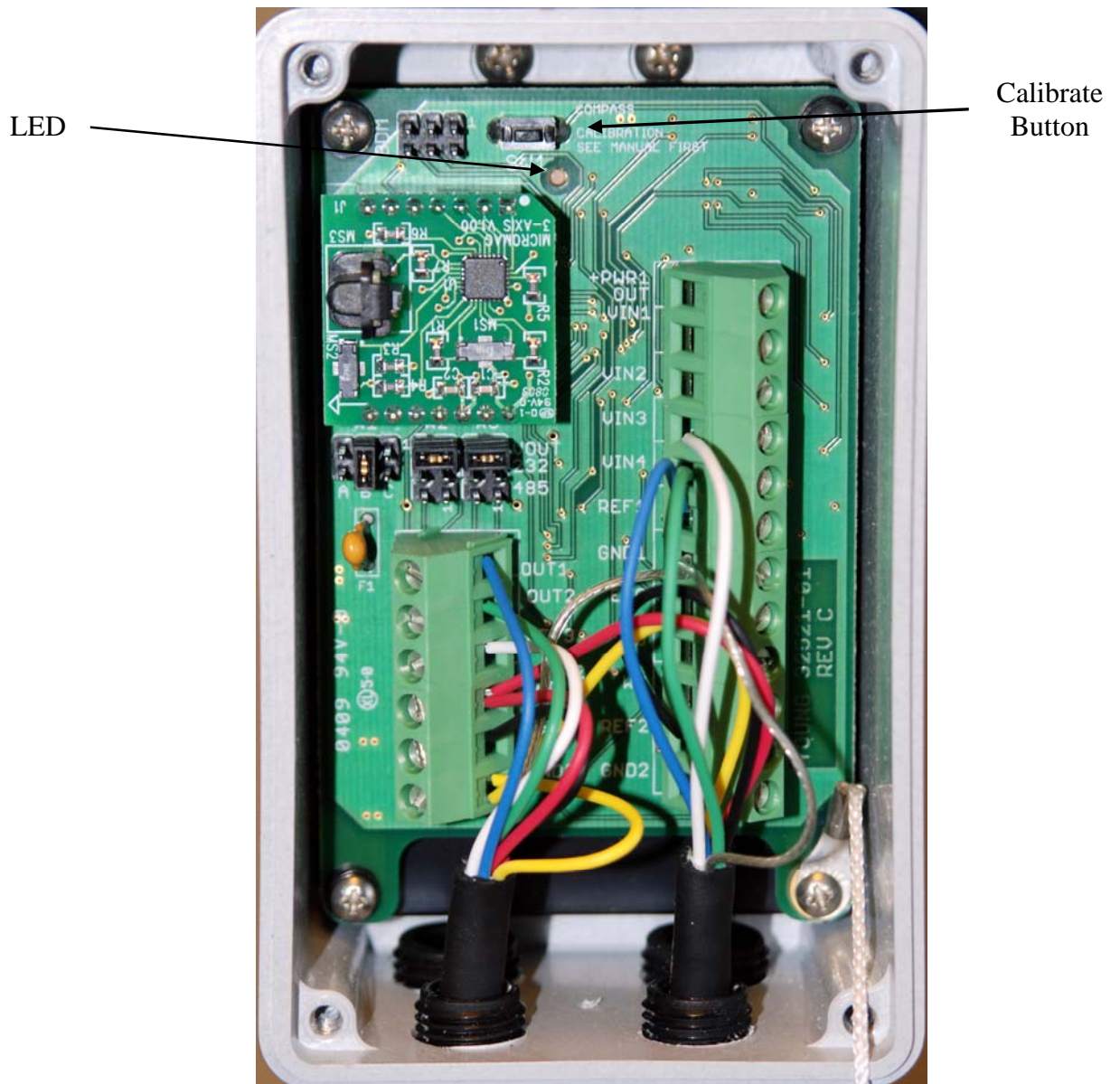

Figure 5. Compass Enclosure and Circuit

# ***Appendix A. Sensor Specifications***

---

## **WIND SPEED & DIRECTION SENSOR (model 85000)**

Operating Temperature: - 50 to +50 °C (- 58 to 122 °F)  
Range: 0 to 70 m/s (0 to 136 knots, 0 to 156 mph)  
Accuracy:  $\pm 0.1$  m/s or  $\pm 2\%$  for range of 0 to 30 m/s

## **ELECTRONIC COMPASS**

Operating Temperature: -50 to +50 °C (- 58 to 122 °F)  
Resolution: 0.5 degrees  
Accuracy:  $\pm 2$  degrees

## **AIR TEMPERATURE AND RELATIVE HUMIDITY PROBE (model HC-S3)**

Measurement Range: - 40 to +60 °C Operating Range: 0 – 100 %

Accuracy:  $\pm 0.4$  °C @ -40 °C                      Accuracy:  $\pm 1.5\%$  @ 23°C  
 $\pm 0.1$  °C @ 0 °C  
 $\pm 0.4$  °C @ 60 °C

## **RAIN GAUGE (model TE525)**

Accuracy:  $\pm 1.0\%$  @ Up to 25.4mm/hour

## **BAROMETRIC PRESSURE**

### **PTB220A (Triple Transducers)**

Temperature Range: -40 to +60 °C (-40 to 140 °F)  
Pressure Range: 500 – 1100 hPa  
Accuracy:  $\pm 0.15$  hPa

### **61302V (Single Transducer)**

Temperature Range: -50 to +60 °C (-58 to 140 °F)  
Pressure Range: 500 – 1100 hPa  
Accuracy:  $\pm 0.3$  hPa rms over -50 to +60 °C  
(serial output)

# Appendix B. Setting Software Device Maps for Loggernet

---

The following is a **Loggernet** example set-up screen when using RAD modems. For longer distances choose a slower baud rate. The default settings for each component should be sufficient to communicate with the MetRanger II.

From the main toolbar select the Setup Screen. Once there start by adding a root. For both the Rad Modem and RF401 radios this will be a ComPort.

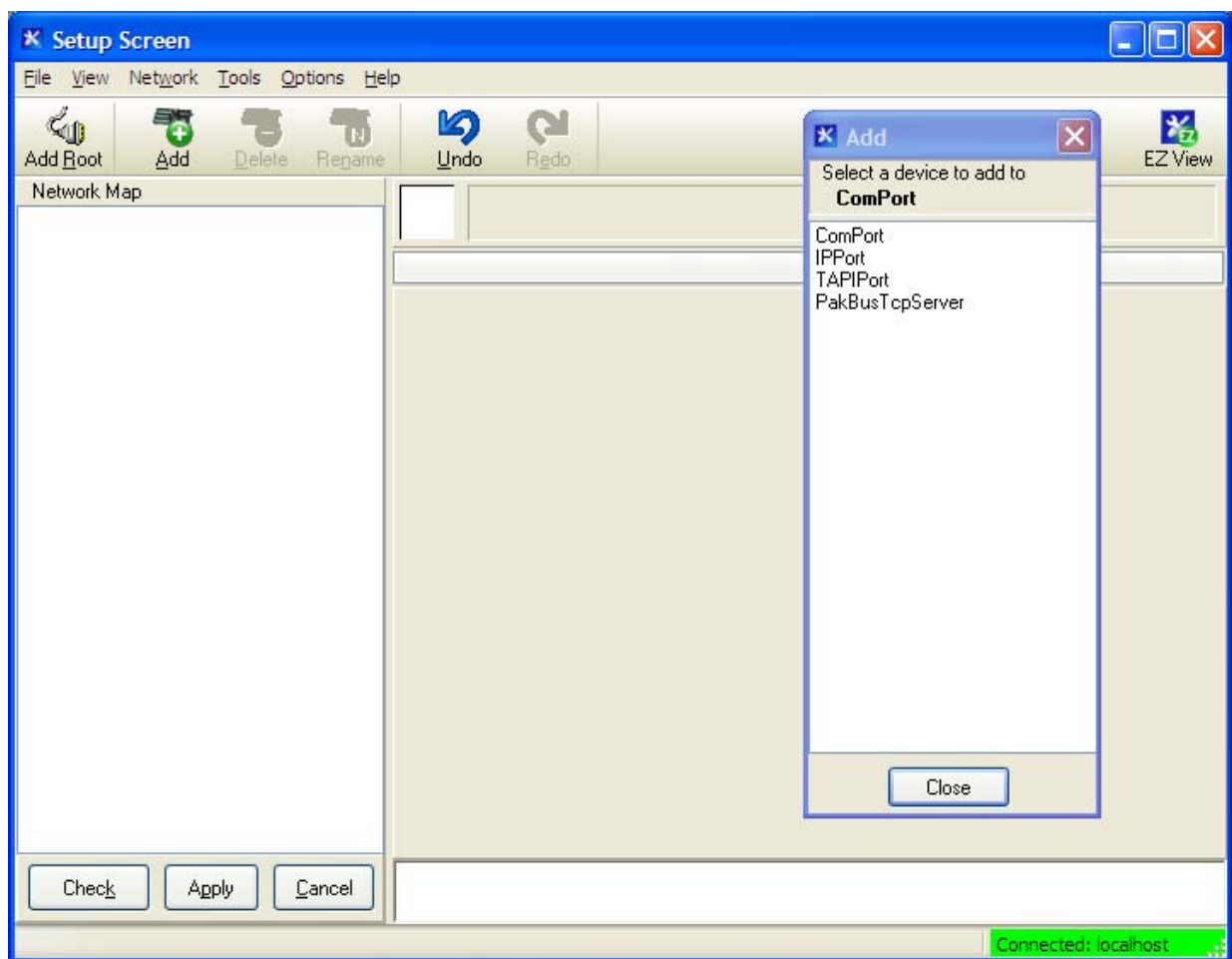

Be sure that the selected ComPort Connection is correct for the computer being used to communicate with the MetRanger II.

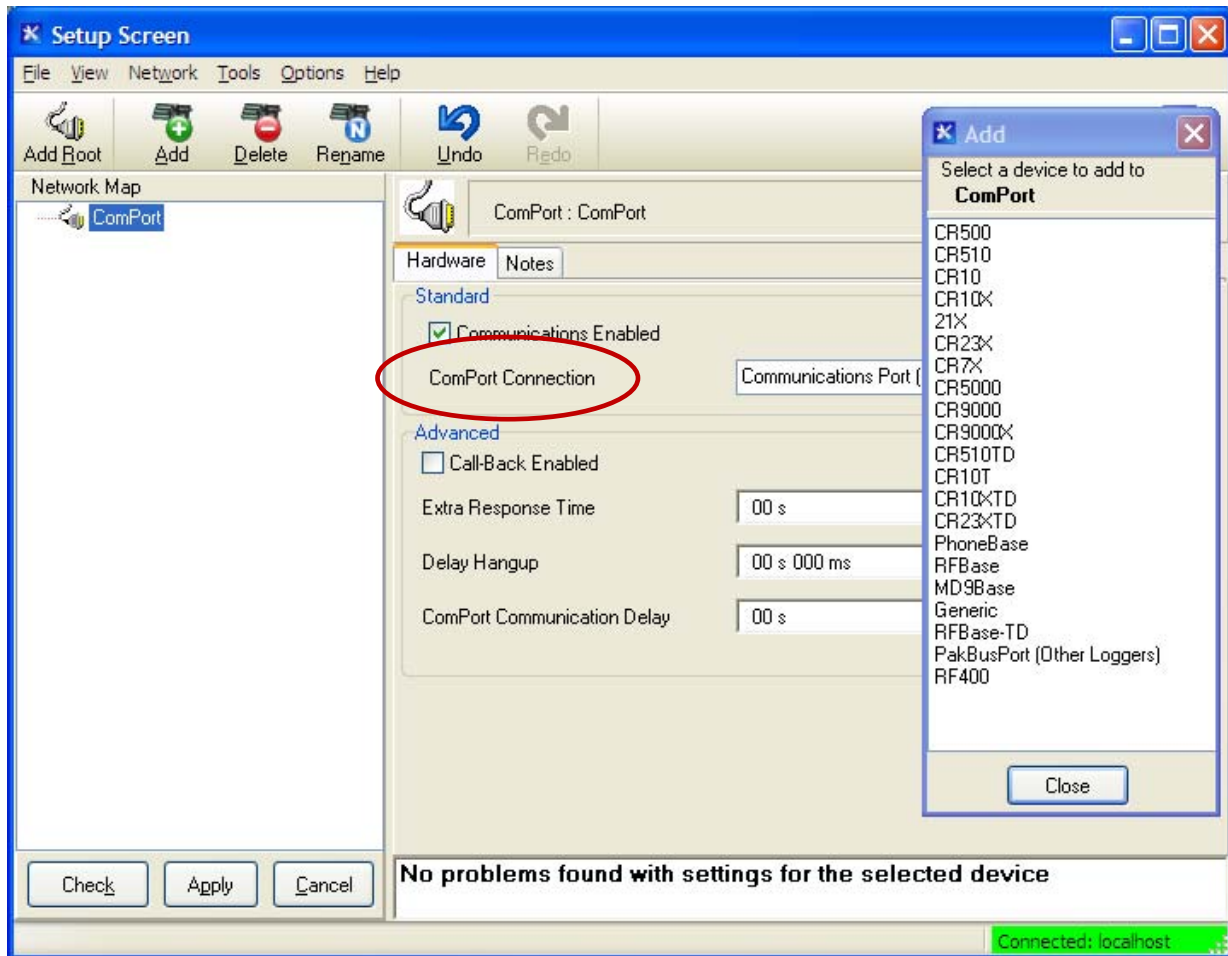

The next step is to add a PakBus Port to the ComPort. This can be done by either hitting the “Add” button or right clicking on the ComPort, and then selecting PakBus Port from the list.

Next add a CR1000 datalogger to the Pakbus Port.

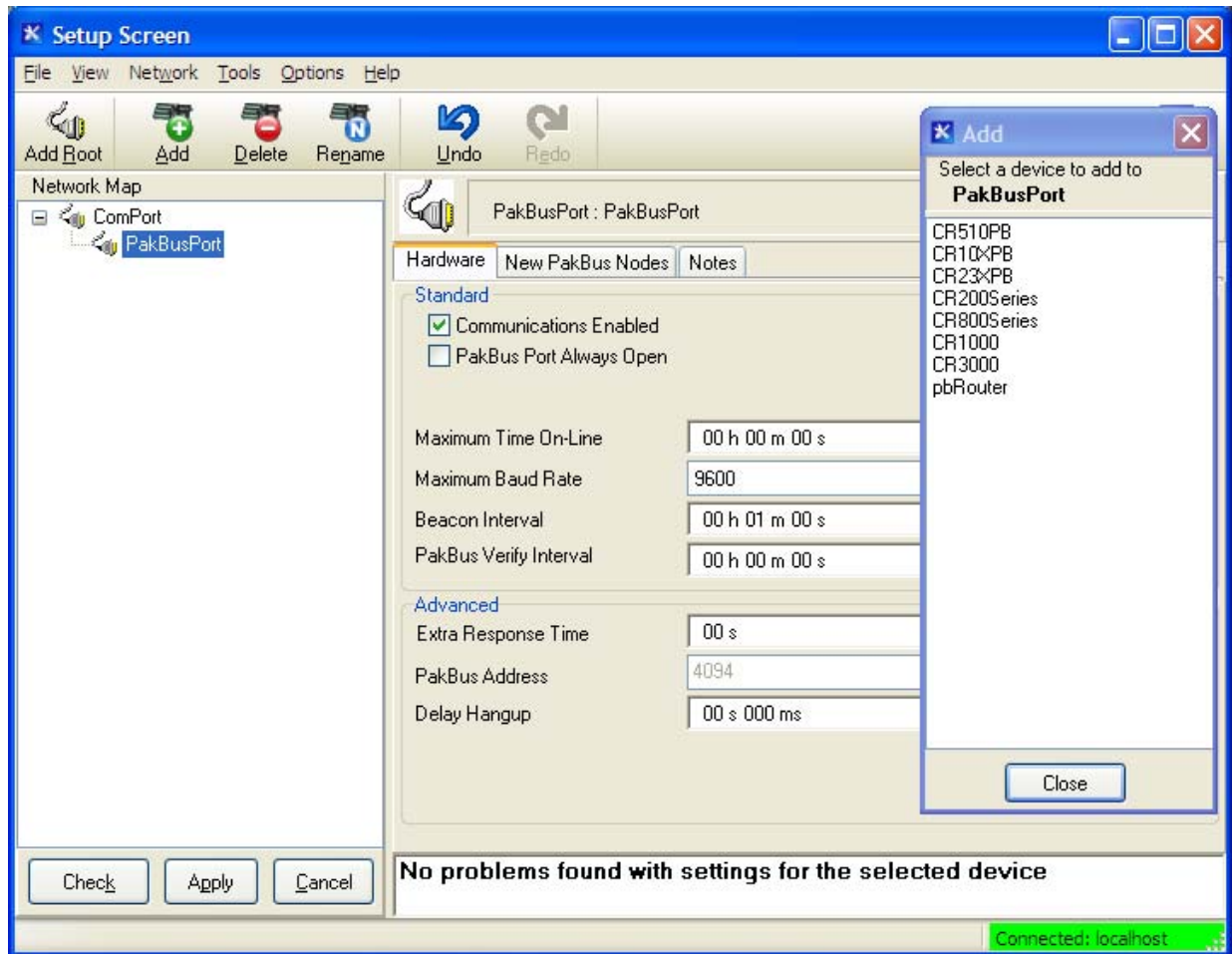

Finally, be sure to “Apply” any changes to the communications setup.

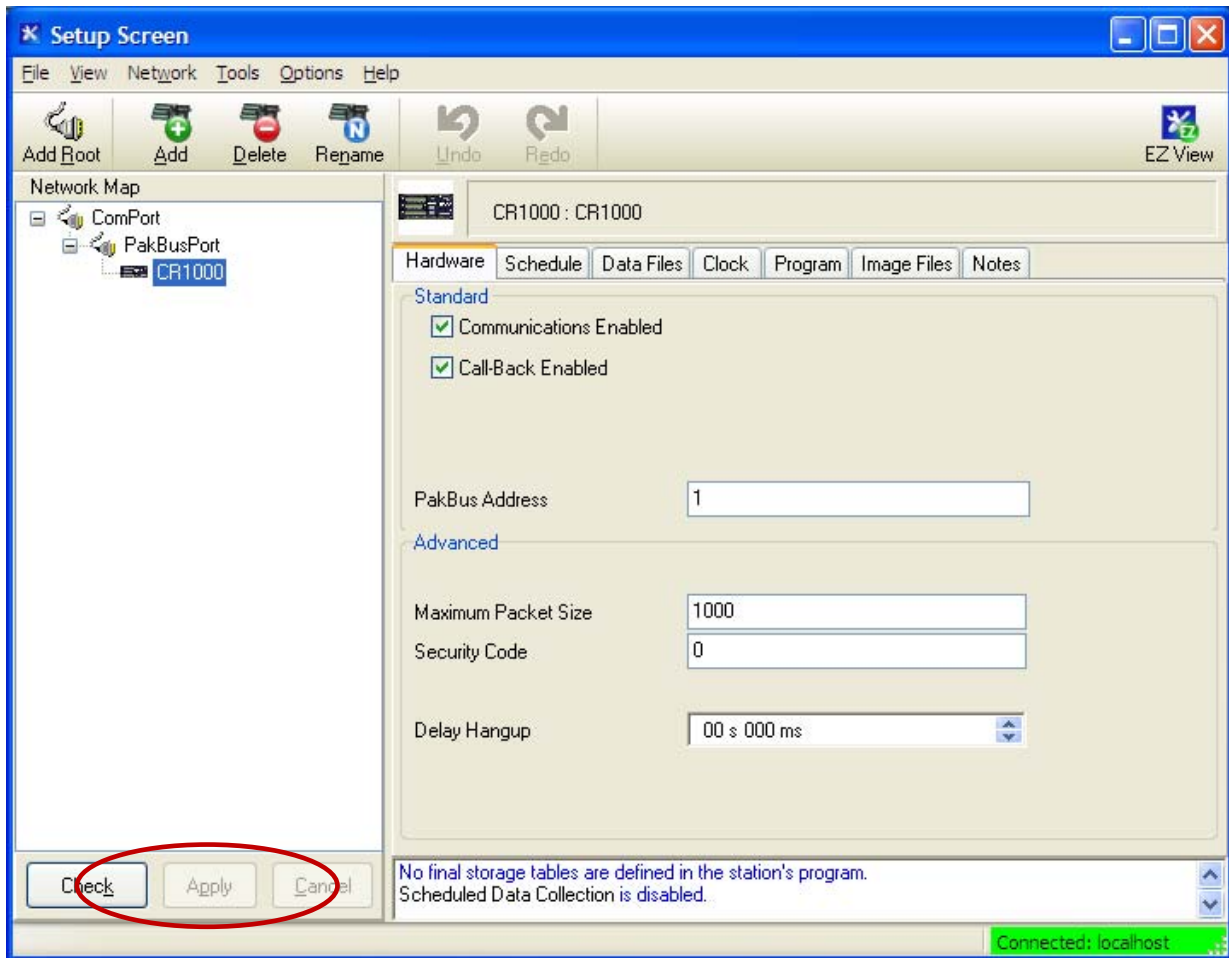

# ***Appendix C. Packing List For The MetRanger II***

---

- ❖ Qualicase™ case with wheels and rubber gripped handles
- ❖ Aluminum tripod
- ❖ RM YOUNG ultrasonic wind sensor with compass
- ❖ CR1000KD handheld keyboard and display
- ❖ RF401 radio
- ❖ White louvered radiation shield with HC-S3 Air Temperature/Relative Humidity Probe, U-bolt and thumb knobs
- ❖ White enclosure with solar panel mounted on lid. Includes internal components:
  - CR1000 datalogger
  - +12V Battery
  - CH100 Charger/regulator
  - Barometric Pressure Sensor
  - RAD modem (optional)
  
- ❖ Raingauge (optional)
- ❖ Mesh Bag #1 (small):
  - screw driver
  - SC929 Laptop Interface cable
  - L10873 and SC12 cables
  - Pconnect software and adaptor.
  
- ❖ Mesh Bag #2 (large):
  - AC power cable
  - Serial I/O cable
  - External +12V battery cable
  - RF401 radio, L14204 antenna (x2), L10873, L15966
  
- ❖ Mesh Bag #3 (large):
  - Guy Wire kit with three foot pegs
  - Velcro straps
  
- ❖ Laminated MetRanger II manual with copy of manual, program, and wiring diagram.
- ❖ Loggernet software
- ❖ ResouceCD

# Appendix D. MetRanger II Program with Wiring & Data Output Labels

---

The following is a copy of the original program residing in the CR1000 datalogger of the MetRanger II. The program can be retrieved from the CR1000 if an electronic version of the program is required.

```
{CR1000}

'//////////////////////////////////WIRING ////////////////////////////////////
'HC-S3 HYGROCLIP AIR TEMPERATURE / RELATIVE HUMIDITY PROBE
'Brown - SE1      = Temperature
'White - SE2      = Relative Humidity
'Green - SW-12    = Power
'Grey - AG        = Signal Ground
'Blue - AG        = Signal Ground
'Clear - G        = Ground

'85000 2D Sonic Anemometer via 32508 (ELECTRONIC COMPASS)
'or new-version 32500 with compatability for 85000.
'Blue - SE9       = Wind Speed
'Green - SE10     = Wind Direction
'White - AG       = Wind Speed & Direction Reference
'Red - SW-12      = Power
'Black - G        = Power Ground
'Yellow - G
'Clear - No Connection on CR10X

'PTB220A Barometric Pressure Sensor
'Red - 12V        = Power
'Black - G        = Power Ground
'Green - C1       = Tx
'Blue - C2        = Rx
'White - C3       = Power Control

'TE525 TIPPING BUCKET RAIN GAUGE (not used in these MRI)
'BLACK - P1       = SIGNAL
'WHITE - AG       = SIGNAL REFERENCE
'CLEAR - AG       = EARTH GROUND

'////////////////////////////////// STATION OUTPUTS ////////////////////////////////////
'5 Minute Data Output Table
'1 Time Stamp
'2 Record Number
'3 Maximum Wind Speed (Knots)
'4 Maximum Wind Speed (M/S)
'5 Mean Horizontal Wind Speed (Knots)
'6 Resultant Mean Wind Speed (Knots)
'7 Mean Wind Direction (Degrees)
'8 Standard Deviation Wind Direction (Degrees)
'9 Mean Horizontal Wind Speed (M/S)
```

'10 Resultant Mean Wind Speed (M/S)  
'11 Mean Wind Direction (Degrees)  
'12 Standard Deviation Wind Direction (Degrees)

'15 Minute Data Output Table  
'1 Time Stamp  
'2 Record Number  
'3 AirTemp (C)  
'4 RH (%)  
'5 WSpd (KNOTS)  
'6 WSpd (Kilometers/hour)  
'7 WSpd (Meters/Second)  
'8 WSpd (feet/Second)  
'9 Wdir (degrees)  
'10 Sample of Average Barometric Press (mbar)  
'11 Minimum Battery Voltage

'Hourly Data Output Table  
'1 Time Stamp  
'2 Record Number  
'3 Average AirTemp (C)  
'4 RH (%)  
'5 Average Dew Point (C)  
'6 Average Wind Chill (C)  
'7 Average Barometric Press\_1 (mbar)  
'8 Average Barometric Press\_2 (mbar)  
'9 Average Barometric Press\_3 (mbar)  
'10 Average of the three Barometric Pressures (mbar)  
'11 WSpd\_KNOT\_Scalar (Knots)  
'12 WSpd\_KNOT\_Uector (Knots)  
'13 Wdir (degrees)  
'14 Standard Deviation of Wind Direction (degrees)

'Daily Data Output Table  
'1 Time Stamp  
'2 Record Number  
'3 Average AirTemp (C)  
'4 Average RH (%)  
'5 Average Dew Point (C)  
'6 Average Wind Chill (C)  
'7 Maximum AirTemp (C)  
'8 Maximum RH (%)  
'9 Maximum Dew Point (C)  
'10 Maximum Wind Chill (C)  
'11 Minimum AirTemp (C)  
'12 Minimum RH (%)  
'13 Minimum Dew Point (C)  
'14 Minimum Wind Chill (C)  
'15 Average Barometric Pressure (mbar)  
'16 Maximum Barometric Pressure (mbar)  
'17 Minimum Barometric Pressure (mbar)  
'18 WSpd\_KNOT\_Scalar  
'19 WSpd\_KNOT\_Vector  
'20 Wdir (degrees)  
'21 Standard Deviation of Wind Direction (degrees)  
'22 WatchDog (number of E08 errors)

```
'23 LowVolt (number of low voltage drops)
'24 Minimum Lithium Battery Voltage
'25 Maximum +12V Battery Voltage
'26 Minimum +12V Battery Voltage
'27 Program Signature

\//////////////////////////////////// DECLARATIONS //////////////////////////////////////
Public AT_C
Public RH_percent
Public WSpd_KNOT
Public Wspd_KM_H
Public WSpd_ms
Public WSpd_ftsc
Public Wdir
Public Dew_Point
Public WChillC
Public Press(4) As String
'Public Precip_mm
Public Batt_Volt
Public watchdog
Public LowVolt
Public LithBatt
Public Prog_Sign

'Dimensioned Variables
Dim Press_String As String * 30
Dim Timer_Sec

'Declare array of flags.
Public Flag_1 As Boolean
Public Flag_8 As Boolean

Alias Press(1) = Press_1
Alias Press(2) = Press_2
Alias Press(3) = Press_3
Alias Press(4) = Press_Avg

'CRBasic angle units are in Radians. Switch to Degrees as CR10 used Degrees.
AngleDegrees

\//////////////////////////////////// OUTPUT SECTION //////////////////////////////////////
DataTable(Table5,true,-1)
  OpenInterval
  DataInterval(0,5,Min,10)
  Maximum(1, WSpd_KNOT, FP2, 0, False)
  Maximum(1, WSpd_ms, FP2, 0, False)
  WindVector(1, WSpd_KNOT, Wdir, FP2, 0, 0, 0, 2)
  FieldNames ("WSpd_KNOT_Scalar:, WSpd_KNOT_Vector:, Wdir:, Std_Dev_Wdir:")
  WindVector(1, WSpd_ms, Wdir, FP2, 0, 0, 0, 2)
  FieldNames ("WSpd_ms_Scalar:, WSpd_ms_Vector:, Wdir_ms:,
Std_Dev_Wdir_ms:")
EndTable

DataTable(Table15,true,-1)
  OpenInterval
```

```

DataInterval(0,15,Min,10)
Sample(1, AT_C, FP2)
Sample(1, RH_percent, FP2)
Sample(1, WSpd_KNOT, FP2)
Sample(1, Wspd_KM_H, FP2)
Sample(1, WSpd_ms, FP2)
Sample(1, WSpd_ftsc, FP2)
Sample(1, Wdir, FP2)
Sample(1, Press_Avg, FP2)
Minimum(1, Batt_Volt, FP2, 0, False)
EndTable

DataTable(Table60,true,-1)
OpenInterval
DataInterval(0,60,Min,10)
Average(1, AT_C, FP2, 0)
Sample(1, RH_percent, FP2)
Average(1, Dew_Point, FP2, 0)
Average(1, WChillC, FP2, 0)
Average(4, Press_1, FP2, 0)
WindVector(1, WSpd_KNOT, Wdir, FP2, 0, 60, 0, 2)
FieldNames ("WSpd_KNOT_Scalar:, WSpd_KNOT_Vector:, Wdir:, Std_Dev_Wdir:")
EndTable

DataTable(Table24,true,-1)
OpenInterval
DataInterval(0,1440,Min,10)
Average(1, AT_C, FP2, 0)
Average(1, RH_percent, FP2, 0)
Average(1, Dew_Point, FP2, 0)
Average(1, WChillC, FP2, 0)
Maximum(1, AT_C, FP2, 0, False)
Maximum(1, RH_percent, FP2, 0, False)
Maximum(1, Dew_Point, FP2, 0, False)
Maximum(1, WChillC, FP2, 0, False)
Minimum(1, AT_C, FP2, 0, False)
Minimum(1, RH_percent, FP2, 0, False)
Minimum(1, Dew_Point, FP2, 0, False)
Minimum(1, WChillC, FP2, 0, False)
Average(1, Press_Avg, FP2, 0)
Maximum(1, Press_Avg, FP2, 0, False)
Minimum(1, Press_Avg, FP2, 0, False)
WindVector(1, WSpd_KNOT, Wdir, FP2, 0, 1440, 0, 2)
FieldNames ("WSpd_KNOT_Scalar:, WSpd_KNOT_Vector:, Wdir:, Std_Dev_Wdir:")
Sample(1, watchdog, FP2)
Sample(1, LowVolt, FP2)
Minimum(1, LithBatt, FP2, 0, False)
Maximum(1, Batt_Volt, FP2, 0, False)
Minimum(1, Batt_Volt, FP2, 0, False)
Sample(1,Prog_Sign, FP2)
EndTable

\//////////////////////////////// PROGRAM //////////////////////////////////
BeginProg
Timer(0,Sec,0)
SerialOpen (Com1,1200,0,0,50)

```



```

DewPoint (Dew_Point,AT_C,RH_perct)

' MEASURE BAROMETRIC PRESSURE (mb)
' This will store readings from (3) sensors as Press_1, Press_2, and 'Press_3, as
well as an average of the (3) as Press_Avg. The Press_Avg is 'used for the Station
Pressure, & the other (3) readings are used in calculating
' Altimeter Setting.
If TimeIntoInterval(0,15,Min) Then
' Turn PTB220 on to start warm up cycle
PortSet(3, 1)
Delay(0,10,Sec)
SerialFlush (Com1)
SerialOut (Com1,"SEND" + CHR(13),"",0,0)
SerialIn (Press_String,Com1,0,"hPa",50)
SplitStr (Press(1),Press_String, " ",4,6)

'Control Port Serial I/O
PortSet(3, 0)
EndIf

'XXXXXXXXXXXXXXXXXXXXXXXXXXXX
'Instruction not used since no Tipping Bucket Rain Gauge is used.
'MEASURE TE525 SENSOR...
' PulseCount (Precip_mm,1,1 ,2,0,0.254,0)
'XXXXXXXXXXXXXXXXXXXXXXXXXXXX

'EVERY 30 MINUTES, MEASURE BATTERY VOLTAGE, SHOW WATCHDOG
ERRORS, NUMBER OF TIMES +12V DROPPED BELOW 9.6V, AND MEASURE
LITHIUM BATTERY VOLTAGE...
If TimeIntoInterval(0,30,Min) Then
Battery(Batt_Volt)
LithBatt=Status.LithiumBattery(1,1)
LowVolt=Status.Low12VCount(1,1)
watchdog=Status.WatchdogErrors(1,1)
EndIf

'Measure Program Signature & Battery Voltage on power up & daily at midnight.
If TimeIntoInterval(0,1440,Min) OR Flag_1 = 0 Then
Battery(Batt_Volt)
Prog_Sign=Status.ProgSignature(1,1)
Flag_1 = 1
EndIf

'5 MINUTE DATA OUTPUT...
CallTable Table5
' 15 MINUTE DATA OUTPUT...
CallTable Table15
'HOURLY DATA OUTPUT...
CallTable Table60
'DAILY DATA OUTPUT...
CallTable Table24
NextScan
EndProg

```

# ***Appendix E. Material Safety Data Sheets***

---



MATERIAL SAFETY DATA SHEET

Form # 853024
Revised: 8/10/05
Supersedes: 12/22/04

I. PRODUCT IDENTIFICATION

Table with 2 columns: Chemical Trade Name (as used on label): Nonspillable Lead-Acid Battery; Chemical Family/Classification: Electric Storage Battery; Manufacturer's Name/Address: EnerSys, P.O. Box 14145, 2366 Bernville Road, Reading, PA 19612-4145; Telephone: For information and emergencies, contact EnerSys' Environmental, Health & Safety Dept. at 610-208-1996; 24-Hour Emergency Response Contact: CHEMTREC DOMESTIC: 800-424-9300 CHEMTREC INT'L: 703-527-3887

II. HAZARDOUS INGREDIENTS/IDENTIFY INFORMATION

Table with 6 columns: Components, CAS Number, Approximate % by Wt. Or Vol., OSHA, ACGIH, NIOSH. Rows include Inorganic Lead Compound (Lead, Lead Dioxide, Antimony, Arsenic, Calcium, Tin), Electrolyte (Sulfuric Acid), Case Material (Polypropylene, Polystyrene, Styrene Acrylonitrile, Acrylonitrile Butadiene Styrene, Styrene Butadiene, Polyvinylchloride, Polycarbonate, Hard Rubber, Polyethylene), and Other (Silicon Dioxide, Sheet Molding Compound).

Inorganic lead and electrolyte (sulfuric acid) are the primary components of every battery manufactured by EnerSys. Other ingredients may be present dependent upon battery type. Contact your EnerSys representative for additional information.

III. PHYSICAL DATA

Table with 2 columns: Property, Value. Properties include Boiling Point (203 - 240° F), Melting Point (N/A), Solubility in Water (100%), Evaporation Rate (Butyl Acetate = 1) (Less than 1), Appearance and Odor (Manufactured article; no apparent odor. Electrolyte is a clear liquid with a sharp, penetrating, pungent odor).

IV. FIRE AND EXPLOSION HAZARD DATA

Table with 2 columns: Flash Point: N/A; Flammable Limits: LEL = 4.1% (Hydrogen Gas), UEL = 74.2%; Extinguishing Media: CO2; foam; dry chemical

Special Fire Fighting Procedures:

If batteries are on charge, shut off power. Use positive pressure, self-contained breathing apparatus. Water applied to electrolyte generates heat and causes it to spatter. Wear acid-resistant clothing.

Unusual Fire and Explosion Hazards:

Highly flammable hydrogen gas is generated during charging and operation of batteries. To avoid risk of fire or explosion, keep sparks or other sources of ignition away from batteries. Do not allow metallic materials to simultaneously contact negative and positive terminals of cells and batteries. Follow manufacturer's instructions for installation and service.

V. REACTIVITY DATA

Stability: Stable

Conditions To Avoid: Prolonged overcharge; sources of ignition

Incompatibility: (Materials to avoid)

Sulfuric Acid: Contact with combustibles and organic materials may cause fire and explosion. Also reacts violently with strong reducing agents, metals, sulfur trioxide gas, strong oxidizers and water. Contact with metals may produce toxic sulfur dioxide fumes and may release flammable hydrogen gas. Lead Compounds: Avoid contact with strong acids, bases, halides, halogenates, potassium nitrate, permanganate, peroxides, nascent hydrogen and reducing agents.

Hazardous Decomposition Products:

Sulfuric Acid: Sulfur trioxide, carbon monoxide, sulfuric acid mist, sulfur dioxide, and hydrogen. Lead Compounds: High temperatures likely to produce toxic metal fume, vapor, or dust; contact with strong acid or base or presence of nascent hydrogen may generate highly toxic arsine gas.

**VI. HEALTH HAZARD DATA**

**Routes of Entry:**

Sulfuric Acid: Harmful by all routes of entry.  
Lead Compounds: Hazardous exposure can occur only when product is heated, oxidized or otherwise processed or damaged to create dust, vapor or fume.

**Inhalation:**

Sulfuric Acid: Breathing of sulfuric acid vapors or mists may cause severe respiratory irritation.  
Lead Compounds: Inhalation of lead dust or fumes may cause irritation of upper respiratory tract and lungs.

**Ingestion:**

Sulfuric Acid: May cause severe irritation of mouth, throat, esophagus and stomach.  
Lead Compounds: Acute ingestion may cause abdominal pain, nausea, vomiting, diarrhea and severe cramping. This may lead rapidly to systemic toxicity and must be treated by a physician.

**Skin Contact:**

Sulfuric Acid: Severe irritation, burns and ulceration.  
Lead Compounds: Not absorbed through the skin.

**Eye Contact:**

Sulfuric Acid: Severe irritation, burns, cornea damage, and blindness.  
Lead Components: May cause eye irritation.

**Effects of Overexposure - Acute:**

Sulfuric Acid: Severe skin irritation, damage to cornea, upper respiratory irritation.  
Lead Compounds: Symptoms of toxicity include headache, fatigue, abdominal pain, loss of appetite, muscular aches and weakness, sleep disturbances and irritability.

**Effects of Overexposure - Chronic:**

Sulfuric Acid: Possible erosion of tooth enamel, inflammation of nose, throat and bronchial tubes.  
Lead Compounds: Anemia; neuropathy, particularly of the motor nerves, with wrist drop; kidney damage; reproductive changes in males and females.

**Carcinogenicity:**

Sulfuric Acid: The International Agency for Research on Cancer (IARC) has classified "strong inorganic acid mist containing sulfuric acid" as a Category I carcinogen, a substance that is carcinogenic to humans. This classification does not apply to liquid forms of sulfuric acid or sulfuric acid solutions contained within a battery. Inorganic acid mist (sulfuric acid mist) is not generated under normal use of this product. Misuse of the product, such as overcharging, may result in the generation of sulfuric acid mist.  
Lead Compounds: Lead is listed as a 2B carcinogen, likely in animals at extreme doses. Proof of carcinogenicity in humans is lacking at present.  
Arsenic: Listed by National Toxicology Program (NTP), International Agency for Research on Cancer (IARC), OSHA and NIOSH as a carcinogen only after prolonged exposure at high levels.

**Medical Conditions Generally Aggravated by Exposure:**

Overexposure to sulfuric acid mist may cause lung damage and aggravate pulmonary conditions. Contact of sulfuric acid with skin may aggravate diseases such as eczema and contact dermatitis. Lead and its compounds can aggravate some forms of kidney, liver and neurologic diseases.

**EMERGENCY AND FIRST AID PROCEDURES:**

**Inhalation:**

Sulfuric Acid: Remove to fresh air immediately. If breathing is difficult, give oxygen.  
Lead: Remove from exposure, gargle, wash nose and lips; consult physician.

**Ingestion:**

Sulfuric Acid: Give large quantities of water; do not induce vomiting; consult physician.  
Lead: Consult physician immediately.

**Skin:**

Sulfuric Acid: Flush with large amounts of water for at least 15 minutes; remove contaminated clothing completely, including shoes.  
Lead: Wash immediately with soap and water.

**Eyes:**

Sulfuric Acid and Lead: Flush immediately with large amounts of water for a least 15 minutes; consult physician.

**Proposition 65:**

Warning: Battery posts, terminals and related accessories contain lead and lead compounds, chemicals known to the State of California to cause cancer and reproductive harm. Batteries also contain other chemicals known to the State of California to cause cancer. Wash hands after handling.

**VII. PRECAUTIONS FOR SAFE HANDLING AND USE**

**Spill or Leak Procedures:**

Stop flow of material, contain/absorb small spills with dry sand, earth, and vermiculite. Do not use combustible materials. If possible, carefully neutralize spilled electrolyte with soda ash, sodium bicarbonate, lime, etc. Wear acid-resistant clothing, boots, gloves, and face shield. Do not allow discharge of unneutralized acid to sewer.

**Waste Disposal Methods:**

Spent batteries: Send to secondary lead smelter for recycling.  
 Place neutralized slurry into sealed containers and handle as applicable with state and federal regulations. Large water-diluted spills, after neutralization and testing, should be managed in accordance with approved local, state and federal requirements. Consult state environmental agency and/or federal EPA.

**VII. PRECAUTIONS FOR SAFE HANDLING AND USE (Cont.)****Handling and Storage:**

Store batteries in cool, dry, well-ventilated areas with impervious surfaces and adequate containment in the event of spills. Batteries should also be stored under roof for protection against adverse weather conditions. Separate from incompatible materials. Store and handle only in areas with adequate water supply and spill control. Avoid damage to containers. Keep away from fire, sparks and heat.

Precautionary Labeling:

POISON - CAUSES SEVERE BURNS

DANGER - CONTAINS SULFURIC ACID

**VIII. CONTROL MEASURES****Engineering Controls:**

Store and handle in well-ventilated area. If mechanical ventilation is used, components must be acid-resistant.

**Work Practices:**

Handle batteries cautiously to avoid spills. Make certain vent caps are on securely. Avoid contact with internal components. Wear protective clothing when filling or handling batteries.

**Respiratory Protection:**

None required under normal conditions. When concentrations of sulfuric acid mist are known to exceed the PEL, use NIOSH or MSHA-approved respiratory protection.

**Protective Gloves:**

Rubber or plastic acid-resistant gloves with elbow-length gauntlet.

**Eye Protection:**

Chemical goggles or face shield.

**Other Protection:**

Acid-resistant apron. Under severe exposure emergency conditions, wear acid-resistant clothing and boots.

**Emergency Flushing:**

In areas where sulfuric acid is handled in concentrations greater than 1%, emergency eyewash stations and showers should be provided, with unlimited water supply.

**IX. OTHER REGULATORY INFORMATION****NFPA Hazard Rating for Sulfuric Acid:**

Flammability (Red) = 0

Reactivity (Yellow) = 2

Health (Blue) = 3

Sulfuric acid is water-reactive if concentrated.

**U.S. DOT:**

EnerSys batteries that are classified as Nonspillable have been tested and meet the nonspillable criteria listed in CFR 49, 173.159 (d) (3) (i) and (ii).

Nonspillable batteries are excepted from CFR 49, Subchapter C requirements, provided that the following criteria are met:

1. The batteries must be protected against short circuits and securely packaged.
2. Each battery and their outer packaging must be plainly and durably marked "NONSPILLABLE" or "NONSPILLABLE BATTERY".

The exception from CFR 49, Subchapter C translates to no proper shipping name, no hazardous class, no UN number, no packing group and no hazardous labels when transporting a nonspillable battery.

Contact your EnerSys representative for additional information regarding the classification of batteries.

**IATA:**

EnerSys batteries that are classified as Nonspillable have been tested and meet the nonspillable criteria listed in IATA Packing Instruction 806 and Special Provision A67. Nonspillable batteries must be packed according to IATA Packing Instruction 806.

These batteries are excepted from all IATA regulations provided that the batteries' terminals are protected against short circuits.

Contact your EnerSys representative for additional information regarding the classification of batteries.

**IX. OTHER REGULATORY INFORMATION (Cont.)**

**IMDG:**  
 EnerSys batteries that are classified as Nonspillable have been tested and meet the nonspillable criteria listed in Special Provision 238. Non-spillable batteries must be packed according to IMDG Packing Instruction P003.  
 These batteries are excepted from all IMDG code provided that the batteries' terminals are protected against short circuits per PP16.  
 Contact your EnerSys representative for additional information regarding the classification of batteries.

**RCRA:**  
 Spent lead-acid batteries are not regulated as hazardous waste by the EPA when recycled, however state and international regulations may vary.

**CERCLA (Superfund) and EPCRA:**  
 (a) Reportable Quantity (RQ) for spilled 100% sulfuric acid under CERCLA (Superfund) and EPCRA (Emergency Planning Community Right to Know Act) is 1,000 lbs.. State and local reportable quantities for spilled sulfuric acid may vary.  
 (b) Sulfuric acid is a listed "Extremely Hazardous Substance" under EPCRA, with a Threshold Planning Quantity (TPQ) of 1,000 lbs.  
 (c) EPCRA Section 302 notification is required if 1,000 lbs. or more of sulfuric acid is present at one site. The quantity of sulfuric acid will vary by battery type. Contact your EnerSys representative for additional information.  
 (d) EPCRA Section 312 Tier 2 reporting is required for batteries if sulfuric acid is present in quantities of 500 lbs. or more and/or if lead is present in quantities of 10,000 lbs. or more.  
 (e) Supplier Notification: This product contains toxic chemicals, which may be reportable under EPCRA Section 313 Toxic Chemical Release Inventory (Form R) requirements.  
If you are a manufacturing facility under SIC codes 20 through 39, the following information is provided to enable you to complete the required reports:

Toxic Chemical	CAS Number	Approximate % by Wt.
Lead	7439-92-1	60
Sulfuric Acid	7664-93-9	10 - 30
* Antimony	7440-36-0	2
* Arsenic	7440-38-2	0.2

If you distribute this product to other manufacturers in SIC Codes 20 through 39, this information must be provided with the first shipment of each calendar year.  
 The Section 313 supplier notification requirement does not apply to batteries, which are "consumer products".  
 \* Not present in all battery types. Contact your EnerSys representative for additional information.

**TSCA:**  
Ingredients in EnerSys' batteries are listed in the TSCA Registry as follows:

Components	CAS Number	TSCA Status
<u>Electrolyte:</u> Sulfuric Acid (H <sub>2</sub> SO <sub>4</sub> )	7664-93-9	Listed
<u>Inorganic Lead Compound:</u>		
Lead (Pb)	7439-92-1	Listed
Lead Oxide (PbO)	1317-36-8	Listed
Lead Sulfate (PbSO <sub>4</sub> )	7446-14-2	Listed
Antimony (Sb)	7440-36-0	Listed
Arsenic (As)	7440-38-2	Listed
Calcium (Ca)	7440-70-2	Listed
Tin (Sn)	7440-31-5	Listed

**CAA:**  
 EnerSys supports preventative actions concerning ozone depletion in the atmosphere due to emissions of CFC's and other ozone depleting chemicals (ODC's), defined by the USEPA as Class I substances. Pursuant to Section 611 of the Clean Air Act Amendments (CAAA) of 1990, finalized on January 19, 1993, EnerSys established a policy to eliminate the use of Class I ODC's prior to the May 15, 1993 deadline.



## MATERIAL SAFETY DATA SHEET

Desi Pak®

**Date-Issued:** 07/06/2004  
**MSDS Ref. No:** 5008  
**Date-Revised:** 07/06/2004  
**Revision No:** New MSDS

### 1. PRODUCT AND COMPANY IDENTIFICATION

**PRODUCT NAME:** Desi Pak®

**GENERAL USE:** Desiccant

#### Manufacturer/Supplier

Süd-Chemie Performance Packaging  
101 Christine Drive  
Rio Grande Industrial Park  
Belen, NM 87002  
**Customer Service:** 505-864-6691

#### 24 HR. EMERGENCY TELEPHONE NUMBERS

**CHEMTREC (U.S.):** (800) 424-9300  
**Canutec** (613) 996-6666  
**Emergency Phone:** 502-634-7200

### 2. COMPOSITION / INFORMATION ON INGREDIENTS

<u>Chemical Name</u>	<u>Wt. %</u>	<u>CAS#</u>
Pouch, Bag, Canister, Stopper or Cap	1 - 75	
Clay	25 - 99	1302-78-9
Silica, quartz	<0.5	14808-60-7

### 3. HAZARDS IDENTIFICATION

#### EMERGENCY OVERVIEW

**PHYSICAL APPEARANCE:** Packaged granular desiccant, size and type vary.

**IMMEDIATE CONCERNS:** There are no health hazards associated with intact desiccant container. However, health hazards do exist as a result of the dusts generated if the container is cut, split or otherwise compromised. Prolonged or excessive exposure to dust may cause lung damage. Dust can be irritating to eyes.

#### POTENTIAL HEALTH EFFECTS

**EYES:** Route of exposure unlikely. Dust may cause a mechanical irritation which can scratch the eye.

**SKIN:** No adverse effects expected.

**INGESTION:** Route of exposure unlikely. Ingestion of large quantities may cause stomach and intestinal distress.

**INHALATION:** Route of exposure unlikely. This material is normally packaged and contained in a pouch, bag or canister. If the container is opened, prolonged or repeated inhalation of the dust may cause lung damage.

#### **SIGNS AND SYMPTOMS OF OVEREXPOSURE**

**EYES:** Redness, irritation, scratched cornea.

**INGESTION:** Upset stomach, intestinal distress.

**INHALATION:** Irritation of nose, throat and upper respiratory tract.

**CARCINOGENICITY:** This product contains crystalline silica which is known to cause cancer. Prolonged or repeated exposure to respirable dust may cause silicosis. This material is packaged and contained in a pouch, bag or cannister that prevent prolonged or repeated inhalation.

---

#### **4. FIRST AID MEASURES**

**EYES:** Immediately flush eyes with plenty of water. Get medical attention, if irritation persists.

**SKIN:** Wash with soap and water.

**INGESTION:** Normally not needed. If large quantities are ingested, seek medical advice.

**INHALATION:** Remove to fresh air. Seek medical attention if cough or other symptoms develop or persist.

---

#### **5. FIRE FIGHTING MEASURES**

**FLASHPOINT AND METHOD:** Material is not flammable

**EXTINGUISHING MEDIA:** Use extinguishing agent applicable to surrounding fire.

**FIRE FIGHTING PROCEDURES:** As in any fire, wear self-contained breathing apparatus operated in pressure-demand mode, (MSHA/NIOSH approved or equivalent) and full protective gear.

---

#### **6. ACCIDENTAL RELEASE MEASURES**

**SMALL SPILL:** No special precautions required.

**LARGE SPILL:** With shovel or scoop, place material into appropriate container.

---

#### **7. HANDLING AND STORAGE**

**HANDLING:** Use of proper hygiene practices in the workplace is recommended.

**STORAGE:** Store in a dry area.

---

## 8. EXPOSURE CONTROLS / PERSONAL PROTECTION

### EXPOSURE GUIDELINES:

#### OSHA HAZARDOUS COMPONENTS (29 CFR 1910.1200)

		<u>EXPOSURE LIMITS</u>			
		<u>OSHA PEL</u>		<u>ACGIH TLV</u>	
		<u>ppm</u>	<u>mg/m<sup>3</sup></u>	<u>ppm</u>	<u>mg/m<sup>3</sup></u>
Clay	<b>TWA</b>			[1]	
Silica, quartz	<b>TWA</b>	[2]		[3]	0.05

### OSHA TABLE COMMENTS:

1. Not Established.
2. Total Dust = (30 mg/m<sup>3</sup>)/(%SiO<sub>2</sub>+2)
3. Respirable

**ENGINEERING CONTROLS:** If user operations generate dust, fume or mist, use ventilation to keep exposure to airborne contaminants below the exposure limit.

### PERSONAL PROTECTIVE EQUIPMENT

**EYES AND FACE:** None needed during normal use and handling.

**SKIN:** Use of proper hygiene practices in the workplace is recommended.

**RESPIRATORY:** Good general ventilation should be sufficient to control airborne levels.

**COMMENTS:** All inert or nuisance dusts, whether mineral, inorganic, or organic, not listed specifically by substance name are covered by the Particulates Not Otherwise Regulated (PNOR) limit which is 5 mg/m<sup>3</sup> for respirable fraction and 15 mg/m<sup>3</sup> for total dust.

---

## 9. PHYSICAL AND CHEMICAL PROPERTIES

**PHYSICAL STATE:** Solid

**ODOR:** None

**SOLUBILITY IN WATER:** Insoluble

---

## 10. STABILITY AND REACTIVITY

**STABLE:** YES

**HAZARDOUS POLYMERIZATION:** NO

---

## 11. TOXICOLOGICAL INFORMATION

**SENSITIZATION:** Not sensitizing

**CARCINOGENICITY:**

**IARC:** Crystalline silica. Classification: Group 1 "carcinogenic to humans".

**NTP:** The National Toxicology Program's Tenth Report on Carcinogens lists respirable crystalline silica as a "Known Human Carcinogen."

**OSHA:** Not listed.

**GENERAL COMMENTS:** Carcinogenicity classification due to a very small amount of crystalline silica.

---

## 12. ECOLOGICAL INFORMATION

**ENVIRONMENTAL DATA:** Low hazard for usual industrial or commercial handling.

**CHEMICAL FATE INFORMATION:** This material is of mineral origin. It is not biodegradable.

---

## 13. DISPOSAL CONSIDERATIONS

**DISPOSAL METHOD:** This product, if discarded as sold, is not a RCRA hazardous waste. Processing, use or contamination of this product may change the waste management options. State and local disposal regulations may differ from federal disposal regulations.

---

## 14. TRANSPORT INFORMATION

**DOT (DEPARTMENT OF TRANSPORTATION)**

**PROPER SHIPPING NAME:** Not regulated

---

## 15. REGULATORY INFORMATION

**UNITED STATES**

**SARA TITLE III (SUPERFUND AMENDMENTS AND REAUTHORIZATION ACT)**

**311/312 HAZARD CATEGORIES:**

**FIRE:** NO **PRESSURE GENERATING:** NO **REACTIVITY:** NO **ACUTE:** NO **CHRONIC:** YES

**313 REPORTABLE INGREDIENTS:** Not listed.

**CERCLA (COMPREHENSIVE RESPONSE, COMPENSATION, AND LIABILITY ACT)**

**CERCLA REGULATORY:** Not listed.

**TSCA (TOXIC SUBSTANCE CONTROL ACT)**

**TSCA STATUS:** All components are listed on the TSCA Inventory or are excluded or exempt.

**RCRA STATUS:** This product, if discarded as sold, is not a RCRA hazardous waste. Processing, use or contamination of this product may change the waste management options. State and local disposal regulations may differ from federal disposal regulations.

**CLEAN AIR ACT**

**APPENDIX A: HAZARDOUS AIR POLLUTANTS (AIR TOXICS):** Not listed.

**CANADA**

**WHMIS (WORKER HAZARDOUS MATERIALS INFORMATION SYSTEM):** This MSDS has been prepared according to the hazard criteria of the Controlled Products Regulations (CPR) and the MSDS contains all of the information required by the CPR.

**CANADA INGREDIENT DISCLOSURE LIST:** Contains component(s) listed on the Canadian Hazardous Products Act Ingredient Disclosure List.

**CANADIAN ENVIRONMENTAL PROTECTION ACT:** All ingredients are listed on the Canadian Domestic Substances List inventory.

**STATE REGULATIONS California**

**CALIFORNIA PROPOSITION 65:** This product does not contain chemical(s) known to the state of California to cause cancer, birth defects, or reproductive harm.

Crystalline silica present is contained within a pouch, canister or bag. There is no exposure to airborne particles of respirable size under normal conditions of use.

---

**16. OTHER INFORMATION**

**APPROVED BY:** Prepared and approved by SHE Dept. Sud-Chemie Inc.

**INFORMATION CONTACT:** 502-634-7492

**REVISION SUMMARY**

**Date-Issued:** 07/06/2004

New MSDS

**MANUFACTURER DISCLAIMER:** The information presented herein is believed to be accurate but is not warranted. Recipients are advised to confirm in advance that the information is current, applicable and suitable to their circumstances.