

**MODEL 32500
ELECTRONIC COMPASS
W/ SERIAL INTERFACE**



REV N081908

MANUAL PN 32500-90

R. M. YOUNG COMPANY

2801 AERO PARK DRIVE, TRAVERSE CITY, MICHIGAN 49686, USA
TEL: (231) 946-3980 FAX: (231) 946-4772

WARRANTY AND ASSISTANCE

This equipment is warranted by CAMPBELL SCIENTIFIC (CANADA) CORP. ("CSC") to be free from defects in materials and workmanship under normal use and service for **twelve (12) months** from date of shipment unless specified otherwise. ***** **Batteries are not warranted.** ***** CSC's obligation under this warranty is limited to repairing or replacing (at CSC's option) defective products. The customer shall assume all costs of removing, reinstalling, and shipping defective products to CSC. CSC will return such products by surface carrier prepaid. This warranty shall not apply to any CSC products which have been subjected to modification, misuse, neglect, accidents of nature, or shipping damage. This warranty is in lieu of all other warranties, expressed or implied, including warranties of merchantability or fitness for a particular purpose. CSC is not liable for special, indirect, incidental, or consequential damages.

Products may not be returned without prior authorization. To obtain a Return Merchandise Authorization (RMA), contact CAMPBELL SCIENTIFIC (CANADA) CORP., at (780) 454-2505. An RMA number will be issued in order to facilitate Repair Personnel in identifying an instrument upon arrival. Please write this number clearly on the outside of the shipping container. Include description of symptoms and all pertinent details.

CAMPBELL SCIENTIFIC (CANADA) CORP. does not accept collect calls.

Non-warranty products returned for repair should be accompanied by a purchase order to cover repair costs.



CAMPBELL SCIENTIFIC
C A N A D A C O R P .

11564 - 149 street - edmonton - alberta - T5M 1W7
tel 780.454.2505 fax 780.454.2655

www.campbellsci.ca



SPECIFICATIONS*

Compass:		
Resolution:	0.5 degrees	
Accuracy:	±2 degrees (rms)	
Wind Speed Input:		
Sensor Type:	AC Frequency Generator	
Sensitivity:	50mV p-p at 10Hz	
Range:	0-2000 Hz	
Wind Direction Input:		
Sensor Type:	Potentiometer	
Range:	0-5000mV = 0 to 355 degrees	
Excitation:	5000mV (limited to 5 mA)	
Voltage Inputs (Auxiliary Sensor Inputs):		
Resolution:	12-bit	
VIN1 and VIN2	0-1000mV	
VIN3 and VIN4	0-5000mV	
Voltage Outputs:		
OUT1	0-5000mV	0-100 m/s wind speed
OUT2	0-5000mV	0-360° true wind direction
Serial Output:		
	Full duplex RS-232, Half duplex RS-485 (2 mS turnaround) 1200, 4800, 9600, 19.2K, & 38.4K baud 8 data, 1 stop, no parity	
Operating Temp: -50°C to 50°C		
Power: 11 to 30 VDC, 40 mA		
Mounting: 1 inch IPS (1.34 inch actual diameter)		
Size:		
	4.75" (12cm) H	
	0.87" (7.3cm) W	
	2.12" (5.3cm) D	

*Specifications subject to change

1.0 INTRODUCTION

The Model 32500 ELECTRONIC COMPASS measures magnetic heading, wind speed and direction signals from YOUNG sensors, and signals from four general purpose voltage inputs. Wind direction input may be combined with compass measurements to obtain true direction. Voltage inputs may be used with YOUNG temperature, humidity, barometric pressure, and other sensors. One voltage input may be configured for connection to a tipping bucket precipitation gauge.

Measurements are available in several serial data formats in either full duplex RS-232 or half-duplex RS-485 signals. Both continuous and polled serial outputs are available. When polled, up to 16 units can be networked together. For marine applications the 32500 produces standard NMEA serial output sentences. Calibrated voltage outputs for wind speed and direction are also provided when the 32500 is connected to a YOUNG wind sensor.

2.0 INSTALLATION

The 32500 is supplied in a weather-resistant enclosure with a mounting adapter that fits 1 inch IPS pipe (1.34 inch nominal diameter). When used with the YOUNG Wind Monitor, the mounting adapter engages the Wind Monitor orientation notch. Refer to the WIRING DIAGRAM for electrical connection details and jumper settings.

It is important to install the 32500 so it remains level during operation. This becomes increasingly important when used at northern and southern latitudes far from the equator since progressively more of the earth's magnetic flux becomes vertical. By keeping the 32500 level at these latitudes, the measurements will be free of the vertical flux influence and remain accurate.

If possible, avoid installing the compass near magnetic devices or machinery. After installation, the compass must be calibrated to correct for local magnetic conditions. If the compass is moved or its local environment changes significantly (machinery moved), the compass should be calibrated again.

3.0 OPERATION

Operation begins automatically when power is applied. Jumpers configure the 32500 for common output formats.

3.1 COMPASS CALIBRATION

When the 32500 is operated for the first time, its internal compass must be calibrated for local conditions. To calibrate the compass, please follow the steps outlined below.

1. Remove cover from compass. Press and hold CALIBRATE button for 5 seconds. The CALIBRATE indicator will begin to blink. Refer to WIRING DIAGRAM to locate CALIBRATE button.
2. Slowly rotate vehicle on which compass is mounted. Steer vehicle in a tight circle and make TWO complete revolutions. Each revolution should take at least one minute. THE COMPASS MUST REMAIN LEVEL DURING CALIBRATION.
3. After two complete revolutions, press and hold CALIBRATE button until indicator stops blinking. Calibration is now complete. Calibration parameters are retained when power is removed.
4. Replace cover. Use this procedure to recalibrate compass at any time.

Serial communication command may also be sent to start and stop the compass calibration. Please see section 4.2 SERIAL COMMANDS for details.

3.2 SIGNAL INPUTS

The 32500 has two special wind speed and direction inputs for YOUNG sensors and four voltage input channels for connection to other meteorological instruments like temperature, humidity, and barometric pressure sensors. Two of the voltage input channels may also be configured as alternative wind speed and wind direction inputs for sensors like the Young 85XXX family. For best performance, sensors should be installed within 3m (10ft.) of the 32500.

Measurements from the voltage input channels are converted to numerical values (0-4000) and sent in the serial ASCII output string:

- VIN1 and VIN2 full scale input is 1000mV DC, therefore:
Input millivolts = Serial output value / 4
- VIN3 and VIN4 full scale input is 5000mV, therefore:
Input millivolts = Serial output value x 1.25

VIN3 and VIN4 may be configured as alternative wind speed and direction inputs using CMD250 in SOFTWARE mode. Please see section 4.2 SERIAL COMMANDS.

Selecting PRECIP or PRECIP POLLED output formats will configure VIN4 to count tips from a tipping bucket precipitation gauge.

Please refer to SERIAL FORMAT DIAGRAM and WIRING DIAGRAM in the Appendix for additional details.

3.3 JUMPERS

W1 JUMPERS A, B, and C, determine serial output format. Jumper configurations and associated output format are listed below: 1 signifies that jumper is installed, 0 signifies that jumper is omitted. See the SERIAL FORMAT DIAGRAM in the Appendix for more details.

A B C	SERIAL OUTPUT FORMAT
0 0 0	ASCII Output
0 0 1	Polled ASCII
0 1 0	NMEA1
0 1 1	NMEA2
1 0 0	RMYT
1 0 1	PRECIP
1 1 0	PRECIP POLLED
1 1 1	SOFTWARE Mode

ASCII and RMYT formats force the serial baud rate to 9600. NMEA formats force the baud rate to 4800.

ASCII and POLLED ASCII are general purpose outputs that may be used with the YOUNG 26800 or devices that can communicate serially. NMEA outputs are generally for marine applications. RMYT is a proprietary format for use with the YOUNG Wind Tracker.

PRECIP and PRECIP POLLED formats configure VIN4 to count tips from a tipping bucket precipitation gauge. (Requires a 10K ohm resistor between EXC and VIN4.)

SOFTWARE mode allows output format and other parameters to be set using serial commands. Please see section 4.0 SERIAL COMMUNICATION and the SERIAL FORMAT DIAGRAM for more information.

W2 & W3 JUMPERS determine output connection type. Only one connection type may be used at a time. Please refer to the WIRING DIAGRAM in the Appendix for jumper location and connection details.

JUMPERS	OUTPUT TYPE
VOUT	Calibrated output for wind speed and direction. OUT1 0-5000mV = 0-100 m/s Wind Speed OUT2 0-5000mV = 0-360 degrees Wind Direction
232	RS-232 full duplex serial
485	RS-485 half duplex serial

4.0 SERIAL COMMUNICATION

The 32500 uses either full-duplex RS-232 or half-duplex RS-485 signals for serial communication. RS-232 is the most simple and operates up distances of 30m (100ft). The RS-485 option is preferred in electrically noisy environments, in applications where multiple units must be networked, or in NMEA marine applications where RS-485 signals are required.

The full duplex RS-232 connection may transmit and receive serial data at the same time.

The RS-485 connection is half-duplex meaning the unit cannot transmit and receive at the same time. The 32500 internally manages the switch between modes.

Many applications require the 32500 to transmit only. However, RS-485 applications that require polling the 32500 or sending commands to it require that the externally connected serial device must be capable of managing its own half-duplex switching from transmit to receive.

At low baud rates with proper cable installation and connections, transmission distances up to 7km (4mi) are possible using RS-485.

Baud rates of 1200, 4800, 9600, 19.2K, and 38.4K baud are available. Most jumper-selected output formats force the baud rate to a

predetermined value. All serial signals use 1 start, 8 data, and 1 stop bit. Any externally connected serial device must be set to the same baud rate as the 32500.

4.1 POLLING

When the serial output format is ASCII POLLED or PRECIP POLLED, the 32500 sends data only when it receives a serial polling command:

Ma!

where 'a' is the unique address of the unit. The default address is 'A' but any alphanumeric character may be used (see POLLING CHARACTER in section 4.2 SERIAL COMMANDS).

See the SERIAL FORMAT DIAGRAM for details on ASCII POLLED data format.

4.2 SERIAL COMMANDS

Serial commands configure operating parameters and perform calibrations.

While most W1 JUMPER settings configure the 32500 to use predetermined parameters, the SOFTWARE mode allows operational parameters to be uniquely configured by serial commands. The parameters are retained even when power is removed.

Commands may be sent using a PC and simple communications programs such as HyperTerm or any other properly configured serial device. All commands that begin with CMD must end with a carriage return (ASCII 13).

Commands may be sent at any time but it may be more convenient to pause 32500 serial output. This is especially necessary with half-duplex RS-485 communication.

Command	Description
CMD100	OPERATE
CMD110	PAUSE
CMD200 n	DAMPING (0=NONE, 1=FAST, 2=SLOW)
CMD210 n	FORMAT 0 ASCII 1 ASCII POLLED 2 NMEA (KNOTS, DIR) 3 NMEA (KNOTS, DIR, TEMP, RH, BARO) 4 RMYT 5 PRECIP 6 PRECIP POLLED 7 ASCII 2 9 DIAGNOSTIC
CMD220 n	OUTPUT RATE (0=15Hz, 1=0.1Hz, 2=2Hz)
CMD230 c	POLL CHARACTER (0-9, A-Z)
CMD240 nn	BAUD RATE (12=1200, 48=4800, 96=9600, 192=19200, 384=38400)
CMD250 n	INPUT TYPE (1=PULSE/POT, 2=VIN3/VIN4)
CMD900	REPORT PARAMETER SETTINGS
CMD910	START COMPASS CALIBRATION
CMD920	STOP COMPASS CALIBRATION
X	Alternative command to enter OPERATE mode
3xESC	Alternative command to PAUSE
3xCNTL-S	Alternative command to START compass calibration
3xCNTL-X	Alternative command to STOP compass calibration

DAMPING determines the amount of averaging applied to the compass measurement.

FORMAT determines serial output format. See Appendix for further details. PRECIP formats substitute tipping bucket precipitation counts for the VIN4 voltage measurement. ASCII 2 omits VIN measurement values from the output string.

INPUT TYPE determines the type of wind speed and wind direction signal to use. Type 1 is for standard WS pulse input wind speed and WD potentiometer wind direction input. Type 2 is for VIN3 (wind speed) and VIN4 (wind direction). With Type 2 voltage inputs, 0 to 5000mV = 0 to 100 m/s wind speed and 0 to 540 degrees wind direction. These alternative inputs allow connection to devices like the Young 85XXX family of 2D Sonic Anemometer.

OUTPUT RATE determines the rate at which serial data strings are sent from the 32500.

POLL CHARACTER sets the unique polling address for the 32500. Any single alphanumeric character may be used.

BAUD RATE selects one of several preset baud rates. If you change baud rate while connected, your external device must also be changed in order to continue communicating with the 32500.

REPORT PARAMETER SETTINGS shows the current state of Damping, Output Format, Output Rate, and Poll Character.

START and STOP COMPASS CALIBRATION commands perform the same function as the CALIBRATE button. See section 3.1 COMPASS CALIBRATION for details regarding the calibration procedure.

5.0 MAINTENANCE

The 32500 requires no maintenance in normal use. Periodic inspection is recommended to verify correct operation.

6.0 WARRANTY

This product is warranted to be free of defects in materials and construction for a period of 12 months from date of initial purchase. Liability is limited to repair or replacement of defective item. A copy of the warranty policy may be obtained from R. M. Young Company.

7.0 CE COMPLIANCE

This product complies with European CE requirements for the EMC Directive. Please note that shielded cable must be used.

Declaration of Conformity

R. M. Young Company
2801 Aero Park Drive
Traverse City, MI 49686 USA

Model 32500 Electronic Compass

The undersigned hereby declares, on behalf of R. M. Young Company that the above-referenced product, to which this declaration relates, is in conformity with the provisions of:

Council Directive 2004/108/EC (December 15, 2004)
on Electromagnetic Compatibility



David Poinsett
R&D Manager
R. M. Young Company

32400 / 32500 SERIAL OUTPUT FORMATS

RMYT serial output for YOUNG Wind Tracker
Six bytes in binary format.

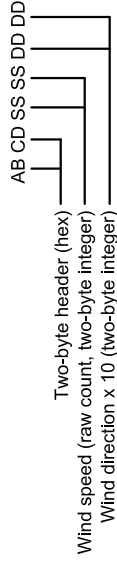

ASCII, POLLED ASCII, PRECIP, or PRECIP POLLED

a ssss dddd vvvv vvvv dddd dddd <CR/LF>

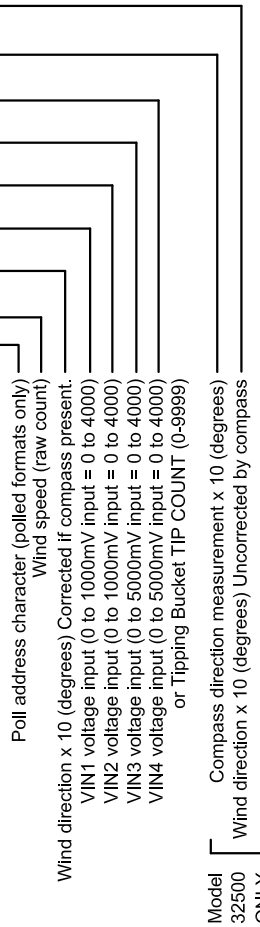

Model 32500 ONLY

NMEA 1 sentence sends wind speed in KNOTS and wind direction in degrees. Model 32500 designates wind direction as TRUE due to compass correction. Model 32400 designates direction as RELATIVE.

\$WIMWV, ddd, a, sss.s, N, A *hh<CR/LF>



WIND SENSOR	M/S	MPH	KNOTS	KM/HR
03002 *	M=0.3752 O=0.2	M=0.8390 O=0.4	M=0.7285 O=0.4	M=1.3505 O=0.7
04101	0.04903	0.1097	0.09526	0.1765
04106	0.04903	0.1097	0.09526	0.1765
05103	0.04903	0.1097	0.09526	0.1765
05106	0.04903	0.1097	0.09526	0.1765
05305	0.05123	0.1146	0.09956	0.1844

The adjacent chart shows multipliers to convert raw pulse count values to standard wind speed units.

* Model 03002 is a cup-wheel type sensor therefore wind speed calculation must use multiplier (M) and offset (O).

Example:
Sensor = 05103 Wind Monitor
Raw pulse count in serial string = 323
MPH Multiplier = 0.1097
Wind Speed = 323 x 0.1097 = 35.4 MPH

NMEA 2 serial output alternates between the NMEA 1 wind sentence and the following transducer sentence which includes measurements for temperature, relative humidity, and barometric pressure.

\$WIXDR,C,000.0,C,TEMP,H,000,P,%RH,P,0.000,B,BARO *hh<CR/LF>

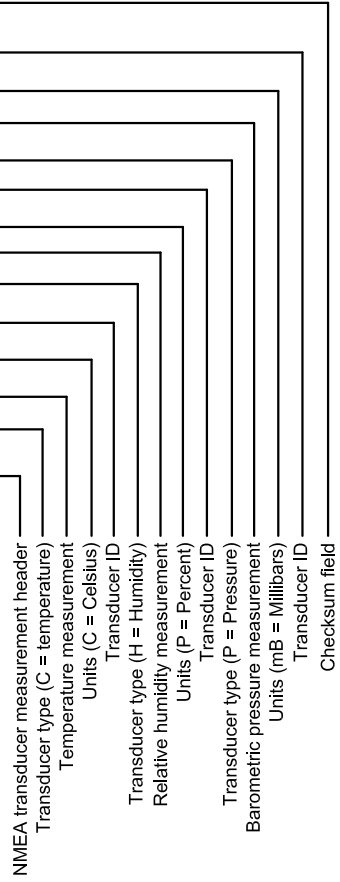

MODEL 32400 / 32500 WIRING DIAGRAM

SERIAL FORMAT	A	B	C	JUMPER W1
ASCII	□	□	□	□
ASCII POLLED	□	□	□	□
NMEA 1	□	□	□	□
NMEA 2	□	□	□	□
RMYT	□	□	□	□
PRECIP	□	□	□	□
PRECIP POLLED	□	□	□	□
SOFTWARE	□	□	□	□

OUTPUT TYPE SUMMARY	W2	W3
VOLTAGE OUTPUT	□ □ □ □	□ □ □ □
VOLTAGE 0-5000 mV	□ □ □ □	□ □ □ □
SERIAL RS-232	□ □ □ □	□ □ □ □
SERIAL RS-485	□ □ □ □	□ □ □ □

OUTPUT TERMINAL FUNCTIONS	OUT 1	OUT 2	REF
RS485	(B)	(A)	REFERENCE
RS232	RECEIVE	TRANSMIT	REFERENCE
VOLTAGE	WIND SPEED	WIND DIRECTION	REFERENCE
0-5000 mV	0-100 m/s	0-360°	

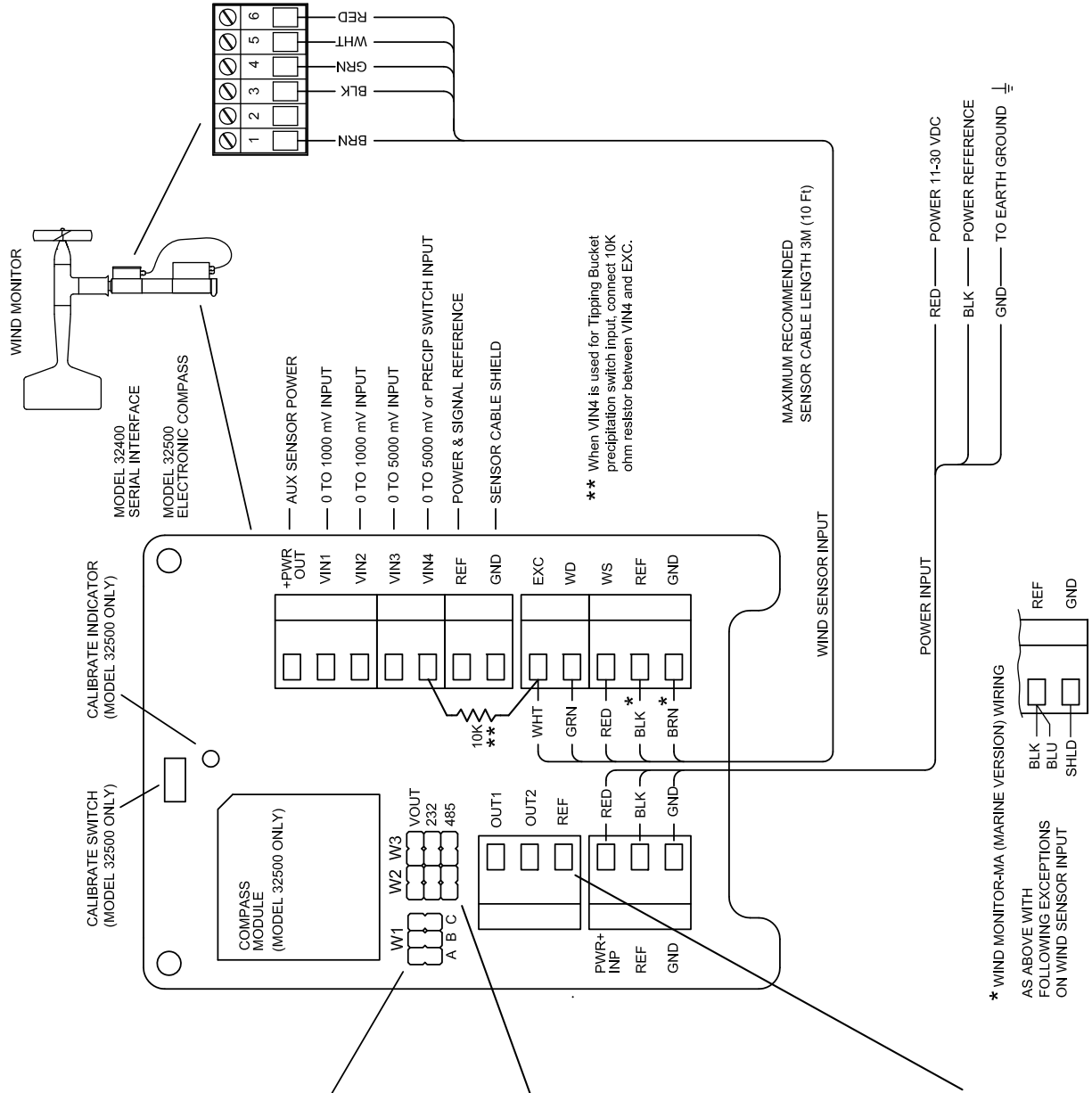

* WIND MONITOR-MA (MARINE VERSION) WIRING AS ABOVE WITH FOLLOWING EXCEPTIONS ON WIND SENSOR INPUT

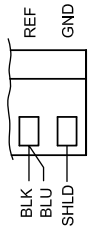

APPENDIX B: WIRING CONNECTIONS

INPUT FROM SONIC ANEMOMETER

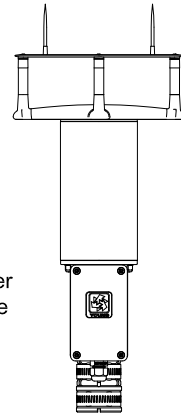

85XXX 2D Sonic Anemometer
Wind direction output must be set to 0-540 degrees. See 85XXX manual.

32500 connected to 85XXX 2D Sonic Anemometer with INPUT TYPE = 2 (WS/WD from VIN3/VIN4).

Keep connection length between 32500 and 85XXX short (less than 1m).

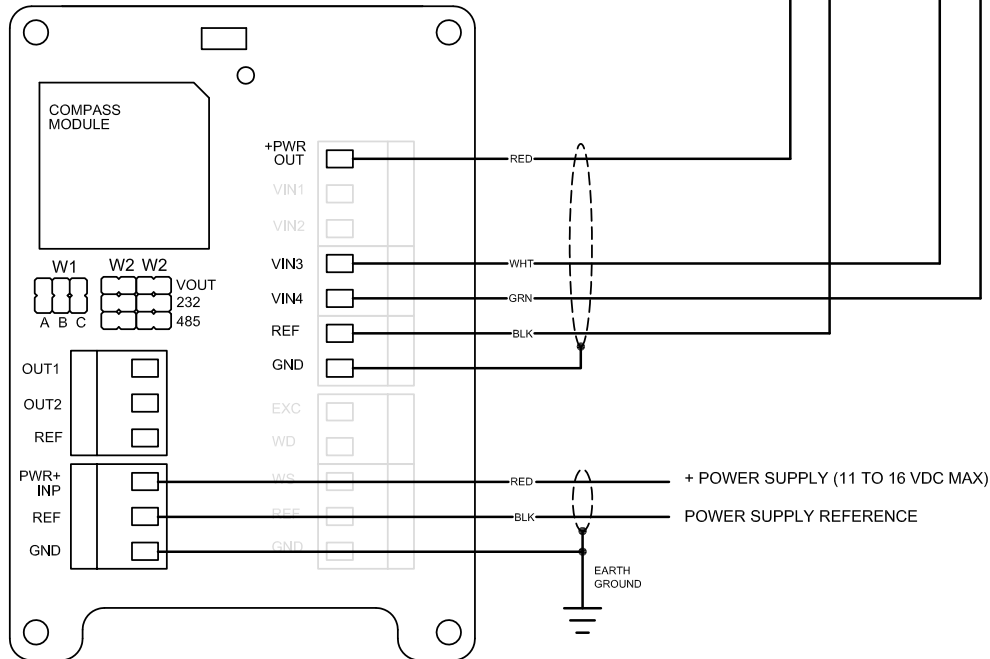
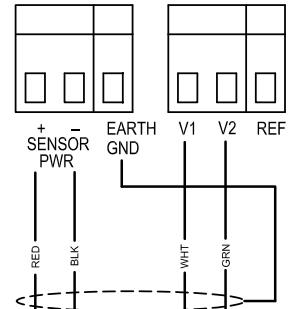

APPENDIX B: WIRING CONNECTIONS

RS-232 SERIAL OUTPUT

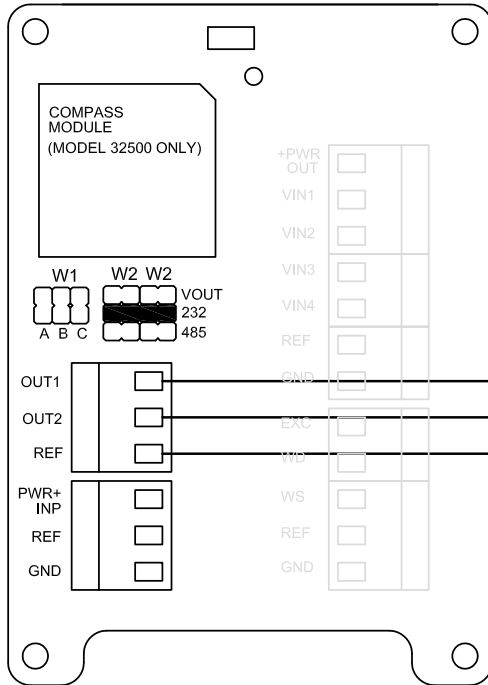

Typical RS-232 connection to PC or other device. 32400/500 jumpers set for RS-232 ASCII output.

If used with PC HyperTerm communications program, set Flow Control to None.

DB-9F
CONNECTOR

RS-485 SERIAL OUTPUT

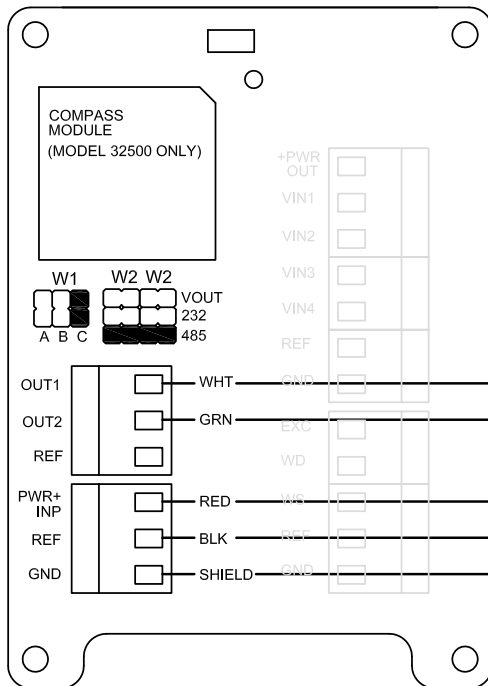

Polled ASCII RS-485 half-duplex serial connection to YOUNG 26800. Note jumper configuration on 32400/500.

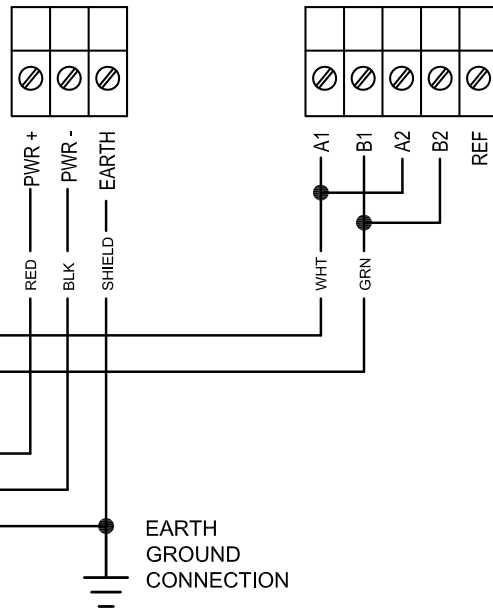

EARTH
GROUND
CONNECTION

APPENDIX B: WIRING CONNECTIONS

Model 06206 Marine Wind Tracker.
Set input to SER for NMEA encoding.
See Marine Wind Tracker manual.

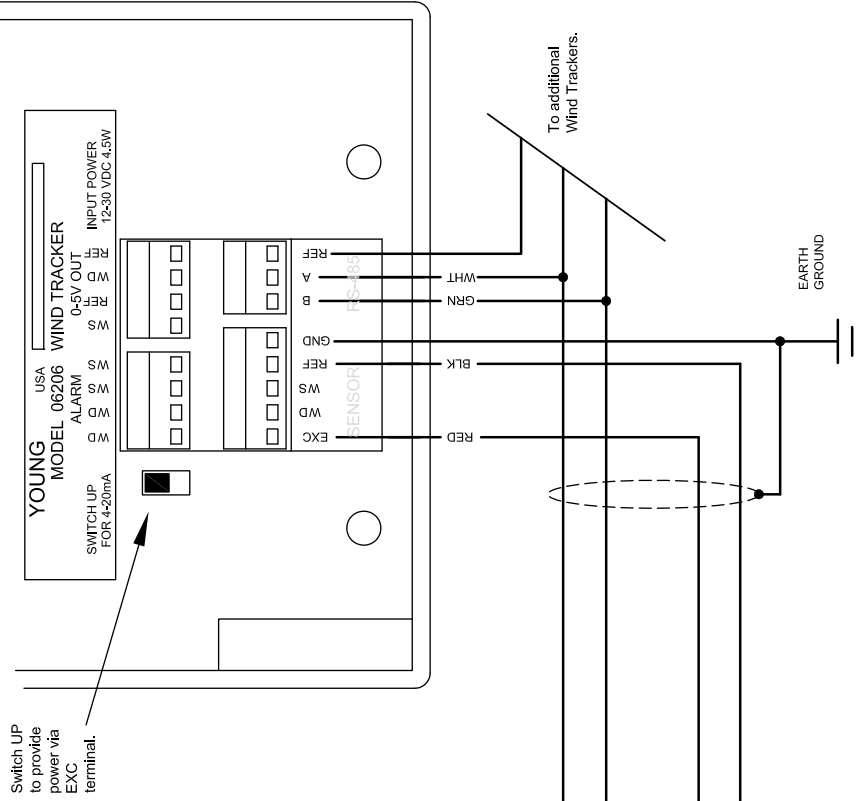

OUTPUT TO 06206 WIND TRACKER
32400 or 32500 with NMEA output connected to 06206 Marine Wind Tracker. Note jumpers at W1, W2, and W3.

